

MIT OpenCourseWare

<http://ocw.mit.edu>

Electromechanical Dynamics

For any use or distribution of this textbook, please cite as follows:

Woodson, Herbert H., and James R. Melcher. *Electromechanical Dynamics*. 3 vols. (Massachusetts Institute of Technology: MIT OpenCourseWare). <http://ocw.mit.edu> (accessed MM DD, YYYY). License: Creative Commons Attribution-NonCommercial-Share Alike

For more information about citing these materials or our Terms of Use, visit: <http://ocw.mit.edu/terms>

Chapter 3

LUMPED-PARAMETER ELECTROMECHANICS

3.0 INTRODUCTION

Having reviewed the derivations of lumped electric circuit elements and rigid-body mechanical elements and generalized these concepts to allow inclusion of electromechanical coupling, we are now prepared to study some of the consequences of this coupling.

In the analysis of lumped-parameter electromechanical systems experience has shown that sufficient accuracy is obtained in most cases by making a lossless model of the coupling system. Thus energy methods are used to provide simple and expeditious techniques for studying the coupling process.

After introducing the method of calculating the energy stored in an electromechanical coupling field, we present energy methods for obtaining forces of electric origin. We shall then study the energy conversion process in coupling systems and finally discuss the formalism of writing equations of motion for complete electromechanical systems. The techniques for analyzing the dynamic behavior of lumped-parameter electromechanical systems are introduced and illustrated in Chapter 5.

3.1 ELECTROMECHANICAL COUPLING

There are four technically important forces of electric origin.

1. The force resulting from an electric field acting on free charge.
2. The force resulting from an electric field acting on polarizable material.
3. The force resulting from a magnetic field acting on a moving free charge (a current).
4. The force resulting from a magnetic field acting on magnetizable material.

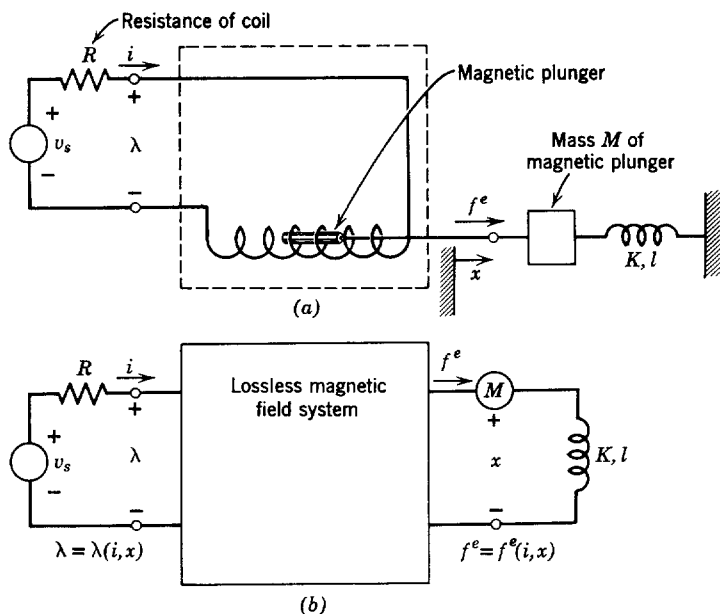

Fig. 3.1.1 (a) A magnetic field electromechanical system; (b) its representation in terms of terminal pairs. Note that the coupling network does not include mechanical energy storages (M) or electrically dissipative elements (R).

Because of the restriction of our treatment to quasi-static systems, the fields that give rise to forces in a particular element are electric or magnetic, but not both. Thus we can consider separately the forces due to electric fields and the forces due to magnetic fields.

To illustrate how the coupling can be taken into account suppose the problem to be considered is the magnetic field system shown in Fig. 3.1.1. The electromechanical coupling occurs between one electrical terminal pair with the variables i and λ and one mechanical terminal pair composed of the node x acted on by the electrical force f^e . It has been demonstrated in Sections 2.1.1 and 2.1.2 that the electrical terminal variables are related by an electrical terminal relation expressible in the form

$$\lambda = \lambda(i, x). \quad (3.1.1)$$

This relation tells us the value of λ , given the values of i and x . We can say, given the *state* (i, x) of the magnetic field system enclosed in the box, that the value of λ is known.

We now make a crucial assumption, motivated by the form of the electrical equation: given the current i and position x , the force of electric origin has a certain single value

$$f^e = f^e(i, x); \quad (3.1.2)$$

that is, the force f^e exerted by the system in the box on the mechanical node is a function of the state (i, x) . This is reasonable if the box includes only those elements that store energy in the magnetic field. Hence all purely electrical elements (inductors that do not involve x , capacitors, and resistors) and purely mechanical elements (all masses, springs, and dampers) are connected to the terminals externally.

Note that f^e is defined as the force of electrical origin applied to the mechanical node in a direction that tends to increase the relative displacement x . Because (3.1.1) can be solved for i to yield

$$i = i(\lambda, x), \tag{3.1.3}$$

the force f^e can also be written as

$$f^e = f^e(\lambda, x). \tag{3.1.4}$$

It is well to remember that the functions of (3.1.2) and (3.1.4) are different because the variables are different; however, for a particular set of i, λ, x the force f^e will have the same numerical value regardless of the equation used.

In a similar way the mechanical force of electric origin for an electric field system (see Fig. 3.1.2) can be written as

$$f^e = f^e(q, x) \tag{3.1.5}$$

or

$$f^e = f^e(v, x). \tag{3.1.6}$$

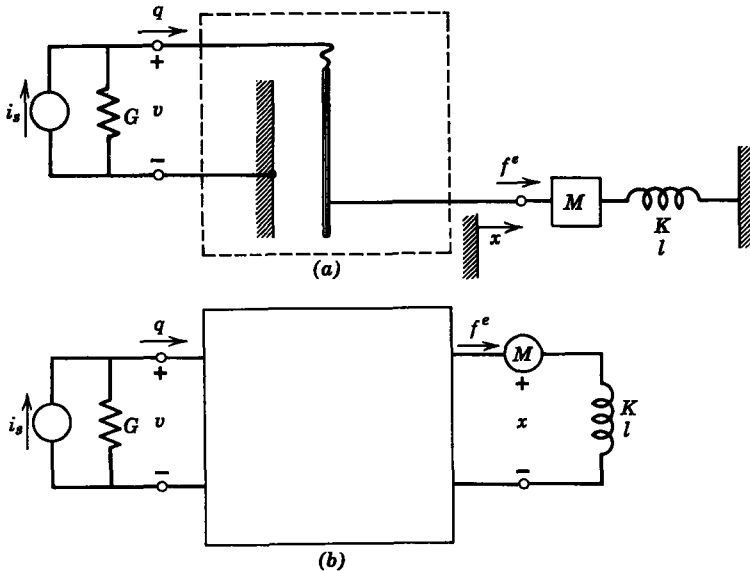

Fig. 3.1.2 (a) An electric field electromechanical system; (b) its representation in terms of terminal pairs. Note that the coupling network does not include mechanical energy storage elements (M) or electrically dissipative elements (G).

When the mechanical motion is rotational, the same ideas apply. We replace force f^e by torque T^e and displacement x by angular displacement θ .

Although the systems of Figs. 3.1.1 and 3.1.2 have only one electrical and one mechanical terminal pair, the discussion can be generalized to any arbitrary number of terminal pairs. For instance, if an electric field system has N electrical terminal pairs and M mechanical terminal pairs for which the terminal relations are specified by (2.1.36), then (3.1.6) is generalized to

$$\begin{aligned} f_i^e &= f_i^e(v_1, v_2, \dots, v_N; x_1, x_2, \dots, x_M), \\ i &= 1, 2, \dots, M, \end{aligned} \quad (3.1.7)$$

where the subscript i denotes the mechanical terminal pair at which f_i^e is applied to the external system by the coupling field. The other forms of f^e can be generalized in the same way.

The next question to be considered is how to determine the force f^e for a particular system. One method is to solve the field problem, find force densities, and then perform a volume integration to find the total force. This process, described in Chapter 8, supports our assumption that f^e has the form of (3.1.2) and (3.1.5). It is often impractical, however, to solve the field problem. A second method of determining f^e is experimental; that is, if the device exists, we can measure f^e as a function of the variables (i and x , λ and x , v and x , or q and x) on which it depends, plot the results, and fit an analytical curve to obtain a function in closed form. This method also has obvious disadvantages.

It is shown in the next section that when the electrical terminal relations are known and the coupling system can be represented as lossless the force f^e can be found analytically. Because electrical lumped parameters are usually easier to calculate and/or measure than mechanical forces, this often provides the most convenient way of determining the mechanical forces of electric origin f_i^e .

3.1.1 Energy Considerations

It will be useful to study some of the general properties of lossless electric and magnetic field energy storages that are functions of geometry. In these considerations we use the conservation of energy (first law of thermodynamics) repeatedly.

As an example, consider again the magnetic field system of Fig. 3.1.1. The system *symbolically* enclosed in the box contains only a magnetic field whose value and therefore energy storage is affected by both electrical and mechanical variables. This coupling network is assumed to be lossless, which means that energy put into the system by the electrical and mechanical terminal pairs is stored in the magnetic field and can be recovered completely

through the terminals. Such a system is often called conservative. We use lossless and conservative as synonyms.

When the total energy stored in the magnetic field is denoted by W_m , the conservation of power for the system can be written as

$$\frac{dW_m}{dt} = i \frac{d\lambda}{dt} - f^e \frac{dx}{dt} \tag{3.1.8}$$

The term dW_m/dt is the time rate of increase in magnetic energy stored, the term $i(d\lambda/dt)$ is the power input at the electrical terminals, and $[-f^e(dx/dt)]$ is the power input at the mechanical terminals. The minus sign on the mechanical power results because f^e is defined as acting on (into) the mechanical node.

Multiplication of (3.1.8) by dt yields an equation for conservation of energy

$$dW_m = i d\lambda - f^e dx \tag{3.1.9}$$

From (3.1.3) and (3.1.4), it is evident that only two of the four variables (i, λ, f^e, x) can be set independently without violating the internal physics of the system. There are further restrictions that the external mechanical and electrical systems impose on the terminal pairs of the box (mechanical and electrical circuit equations). If, however, we think of the coupling network as being temporarily disconnected from the electrical and mechanical circuits, we can choose two *independent variables*, say (λ, x) , which through the terminal relations stipulate i and f^e . Our choice of λ and x is motivated by (3.1.9), which shows how incremental changes in these variables are related to incremental changes in the magnetic stored energy W_m . The evaluation of the change in W_m when λ and/or x are varied by finite amounts requires an integration of (3.1.9). This is a line integration through variable space. For the example being considered (Fig. 3.1.1) there are two independent variables (λ, x) ; thus variable space is two-dimensional, as illustrated in Fig. 3.1.3. Independence of variables is indicated by orthogonality of axes. Suppose it is

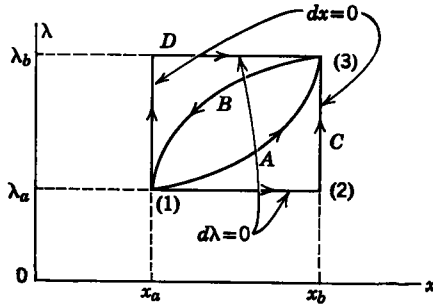

Fig. 3.1.3 Two-dimensional variable space.

desired to find the change in stored energy when the independent variables are changed from the point (λ_a, x_a) to the point (λ_b, x_b) . To evaluate a line integral we must specify the path of integration; an infinite number of possible paths exist between the two points. A property of a conservative system, however, is that its stored energy is a function of its *state* (i.e., of the particular values of λ and x that exist) and does not depend on what succession of variable values or what path through variable space was used to reach that state. A consequence of this property is that if the system variables are made to change along path *A* from (λ_a, x_a) to (λ_b, x_b) in Fig. 3.1.3 and then along path *B* back to (λ_a, x_a) , the net change in stored energy W_m during the process is zero.

In a conservative system the change in stored energy between any two points in variable space is independent of the path of integration. Thus we can select the path that makes the integration easiest. As an example, consider the evaluation of the change in energy between points (λ_a, x_a) and (λ_b, x_b) in Fig. 3.1.3. Along segment 1-2, $d\lambda = 0$; and along segment 2-3, $dx = 0$. Thus, using path *C*, integration of (3.1.9) takes on the particular form

$$W_m(\lambda_b, x_b) - W_m(\lambda_a, x_a) = - \int_{x_a}^{x_b} f^e(\lambda_a, x) dx + \int_{\lambda_a}^{\lambda_b} i(\lambda, x_b) d\lambda. \quad (3.1.10)$$

If, alternatively, we wish to evaluate the integral along path *D* in Fig. 3.1.3, the result is

$$W_m(\lambda_b, x_b) - W_m(\lambda_a, x_a) = \int_{\lambda_a}^{\lambda_b} i(\lambda, x_a) d\lambda - \int_{x_a}^{x_b} f^e(\lambda_b, x) dx. \quad (3.1.11)$$

The energy difference as evaluated by (3.1.10) and (3.1.11) must, of course, be the same.

The integrations given in (3.1.10) and (3.1.11) have a simple physical significance. The integrations of (3.1.10) represent putting energy into the network in two successive steps. First we put the system together mechanically (integrate on x) while keeping λ constant. In general, this operation requires doing work against the force f^e , and this is the contribution of the first integral in (3.1.10) to the energy stored in the coupling network. Then we put energy in through the electrical terminals, keeping the geometry (x) fixed. The second integral is the energy supplied by an electrical source which provides the excitation λ . In (3.1.11) these successive steps are reversed in order.

We always define electrical terminal pairs that account for the excitation of all electric or magnetic fields in the system. Then, when the electrical terminal variables are zero ($\lambda_a = 0$ in the present example), we can say that there is no force of electrical origin. The difference between (3.1.10) and (3.1.11) with $\lambda_a = 0$ is crucial, for in the first the contribution of f^e to the integration is zero [$f^e(0, x) = 0$], whereas in the second we must know f^e to

carry out the integration; that is, by first integrating on the mechanical variables and then on the electrical variables we can determine W_m from the electrical terminal relations. Physically, this simply means that if we put the system together mechanically when no force is required we can account for all the energy stored by putting it in through the electrical terminal pairs.

An example of a system in which there will be energy stored in the network and a force of electrical origin even with no external electrical excitation is the permanent magnet device of Example 2.1.3. In that example, however, it was shown that we could replace the permanent magnet with an externally excited terminal pair; hence this case imposes no restriction on our development.

We can also study electric field systems using the conservation of energy. For the example in Fig. 3.1.2, with the electrical energy stored in the system denoted by W_e , the conservation of power can be written as

$$\frac{dW_e}{dt} = v \frac{dq}{dt} - f^e \frac{dx}{dt}, \quad (3.1.12)$$

and multiplication by dt yields the conservation of energy

$$dW_e = v dq - f^e dx. \quad (3.1.13)$$

A comparison of (3.1.9) and (3.1.13) shows that the description of lossless magnetic field systems can be used directly for electric field systems by replacing W_m by W_e , i by v , and λ by q . All the mathematical processes are exactly the same.

These examples are systems with one electrical and one mechanical terminal pair. The results can be extended to systems with any arbitrary number of terminal pairs; for example, consider an electric field system with N electrical terminal pairs and M rotational mechanical terminal pairs. Then the conservation of energy can be written as

$$\frac{dW_e}{dt} = \sum_{i=1}^N v_i \frac{dq_i}{dt} - \sum_{i=1}^M T_i^e \frac{d\theta_i}{dt}, \quad (3.1.14)$$

where v_i and q_i are the voltage and charge associated with the i th electrical terminal pair, T_i^e and θ_i are the torque and angular displacement at the i th mechanical terminal pair, and W_e represents the total electric energy stored in the system.

Multiplication of (3.1.14) by dt yields

$$dW_e = \sum_{i=1}^N v_i dq_i - \sum_{i=1}^M T_i^e d\theta_i. \quad (3.1.15)$$

For this system there will be N electrical terminal relations of the general form

$$v_i = v_i(q_1, q_2, \dots, q_N; \theta_1, \theta_2, \dots, \theta_M); i = 1, 2, \dots, N \quad (3.1.16)$$

and M mechanical terminal relations

$$T_i^e = T_i^e(q_1, q_2, \dots, q_N; \theta_1, \theta_2, \dots, \theta_M); i = 1, 2, \dots, M. \quad (3.1.17)$$

As a result of the use of (3.1.16) and (3.1.17), (3.1.15) is expressed as a function of $(N + M)$ independent variables, the N charges and M angles. Thus the stored energy can be written in general as

$$W_e = W_e(q_1, q_2, \dots, q_N; \theta_1, \theta_2, \dots, \theta_M) \quad (3.1.18)$$

and W_e can be obtained by integrating (3.1.15) along any convenient path through the $(N + M)$ -dimensional variable space.

Further generalization of these ideas to magnetic field systems and translational mechanical terminal pairs is straightforward and is not carried out here (see Table 3.1). Example 3.1.1 illustrates the line integration that has been described.

3.1.2 Mechanical Forces of Electric Origin

Now that we have specified the formalism by which we calculate stored energy, we shall derive mechanical forces of electric origin by using the conservation of energy.

3.1.2a Force-Energy Relations

To start with a simple example, we consider again the magnetic field system of Fig. 3.1.1 which was described mathematically by (3.1.3), (3.1.4), and (3.1.9). From these expressions it is clear that the magnetic stored energy W_m is expressible as a function of the two independent variables λ and x .

$$W_m = W_m(\lambda, x). \quad (3.1.19)$$

We shall find that if the system is to be conservative the energy must be a single-valued function of the independent variables (λ, x) with finite second partial derivatives. Making this restriction on W_m we can formally take the total differential of (3.1.19) to obtain

$$dW_m = \frac{\partial W_m}{\partial \lambda} d\lambda + \frac{\partial W_m}{\partial x} dx, \quad (3.1.20)$$

where the partial derivatives are taken by using λ and x as independent variables. When (3.1.20) is subtracted from (3.1.9), the result is

$$0 = \left(i - \frac{\partial W_m}{\partial \lambda} \right) d\lambda - \left(f^e + \frac{\partial W_m}{\partial x} \right) dx. \quad (3.1.21)$$

Table 3.1 Energy Relations for an Electromechanical Coupling Network with N Electrical and M Mechanical Terminal Pairs*

Magnetic Field Systems	Electric Field Systems
Conservation of Energy	
$dW_m = \sum_{j=1}^N i_j d\lambda_j - \sum_{j=1}^M f_j^e dx_j \quad (a)$	$dW_e = \sum_{j=1}^N v_j dq_j - \sum_{j=1}^M f_j^e dx_j \quad (b)$
$dW'_m = \sum_{j=1}^N \lambda_j di_j + \sum_{j=1}^M f_j^e dx_j \quad (c)$	$dW'_e = \sum_{j=1}^N q_j dv_j + \sum_{j=1}^M f_j^e dx_j \quad (d)$
Forces of Electric Origin, $j = 1, \dots, M$	
$f_j^e = - \frac{\partial W_m(\lambda_1, \dots, \lambda_N; x_1, \dots, x_M)}{\partial x_j} \quad (e)$	$f_j^e = - \frac{\partial W_e(q_1, \dots, q_N; x_1, \dots, x_M)}{\partial x_j} \quad (f)$
$f_j^e = \frac{\partial W'_m(i_1, \dots, i_N; x_1, \dots, x_M)}{\partial x_j} \quad (g)$	$f_j^e = \frac{\partial W'_e(v_1, \dots, v_N; x_1, \dots, x_M)}{\partial x_j} \quad (h)$
Relation of Energy to Coenergy	
$W_m + W'_m = \sum_{j=1}^N \lambda_j i_j \quad (i)$	$W_e + W'_e = \sum_{j=1}^N v_j q_j \quad (j)$
Energy and Coenergy from Electrical Terminal Relations	
$W_m = \sum_{j=1}^N \int_0^{\lambda_j} i_j(\lambda_1, \dots, \lambda_{j-1}, \lambda'_j, 0, \dots, 0; x_1, \dots, x_M) d\lambda'_j \quad (k)$	$W_e = \sum_{j=1}^N \int_0^{q_j} v_j(q_1, \dots, q_{j-1}, q'_j, 0, \dots, 0; x_1, \dots, x_M) dq'_j \quad (l)$
$W'_m = \sum_{j=1}^N \int_0^{i_j} \lambda_j(i_1, \dots, i_{j-1}, i'_j, 0, \dots, 0; x_1, \dots, x_M) di'_j \quad (m)$	$W'_e = \sum_{j=1}^N \int_0^{v_j} q_j(v_1, \dots, v_{j-1}, v'_j, 0, \dots, 0; x_1, \dots, x_M) dv'_j \quad (n)$

* The mechanical variables f_j and x_j can be regarded as the j th force and displacement or the j th torque T_j and angular displacement θ_j .

The variables λ and x are independent. Thus $d\lambda$ and dx can have arbitrary values, and the equation must be satisfied by requiring the coefficients of $d\lambda$ and dx to be zero:

$$i = \frac{\partial W_m(\lambda, x)}{\partial \lambda}, \quad (3.1.22)$$

$$f^e = -\frac{\partial W_m(\lambda, x)}{\partial x}. \quad (3.1.23)$$

If the stored energy is known, the electrical and mechanical terminal relations can now be calculated.

Equations 3.1.22 and 3.1.23 can be generalized to describe a system with arbitrary numbers of electrical and mechanical terminal pairs (see Table 3.1). To illustrate this generalization we consider again the electric field system of N electrical terminal pairs and M rotational terminal pairs which was described mathematically by (3.1.14) to (3.1.18). We now take the total differential of (3.1.18),

$$dW_e = \sum_{i=1}^N \frac{\partial W_e}{\partial q_i} dq_i + \sum_{i=1}^M \frac{\partial W_e}{\partial \theta_i} d\theta_i. \quad (3.1.24)$$

Subtraction of (3.1.24) from (3.1.15) yields

$$0 = \sum_{i=1}^N \left(v_i - \frac{\partial W_e}{\partial q_i} \right) dq_i - \sum_{i=1}^M \left(T_i^e + \frac{\partial W_e}{\partial \theta_i} \right) d\theta_i. \quad (3.1.25)$$

All N of the q_i 's and M of the θ_i 's are independent. Thus each coefficient of dq_i and $d\theta_i$ must be equal to zero:

$$v_i = \frac{\partial W_e}{\partial q_i}; \quad i = 1, 2, \dots, N, \quad (3.1.26)$$

$$T_i^e = -\frac{\partial W_e}{\partial \theta_i}; \quad i = 1, 2, \dots, M. \quad (3.1.27)$$

These expressions are generalizations of (3.1.22) and (3.1.23) to describe systems with arbitrary numbers of terminal pairs. They indicate that when the stored energy W_e is known as a function of the independent variables all terminal relations can be calculated (see Table 3.1).

It is usually easier in practice to determine the electrical terminal relations by calculation or measurement than it is to determine the mechanical terminal relations or the stored energy. We have seen that the electrical terminal relations are sufficient to evaluate the stored energy if we choose a path of integration in variable space that keeps electrical excitations zero while mechanical variables are brought to their final values. Once the stored energy is known, the force f^e can be calculated as a derivative of the stored

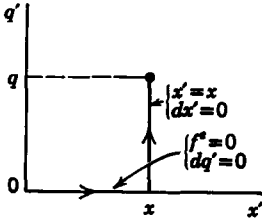

Fig. 3.1.4 Variable space for system of Fig. 3.1.2.

energy [see (3.1.23) or (3.1.27)]. Thus the properties of a coupling system can be determined completely if the electrical terminal relations are known and the system is represented by a conservative model.

To illustrate these ideas consider the electric field system of Fig. 3.1.2 for which the electrical terminal relation is

$$v = v(q, x). \quad (3.1.28)$$

The path of integration in the q - x plane to be used in evaluating stored energy W_e is shown in Fig. 3.1.4. If we use (3.1.13), the energy at point (q, x) is

$$W_e(q, x) = \int_0^x -f^e(0, x') dx' + \int_0^q v(q', x) dq'. \quad (3.1.29)$$

In this expression and in Fig. 3.1.4 the primes denote running variables and (q, x) represents the fixed end point of the line integration. The first term on the right of (3.1.29) is zero because f^e is the force of interaction between charges and electric fields, and with no charge ($q = 0$) f^e must be zero. Thus (3.1.29) can be written for this particular path of integration in the simpler form

$$W_e(q, x) = \int_0^q v(q', x) dq'. \quad (3.1.30)$$

This result can be generalized in a straightforward way to magnetic field coupling systems, rotational mechanical systems, and multiterminal-pair systems. The generalized force and energy relations are summarized in Table 3.1. This table is intended to illustrate the generality and interrelations of the equations. These general equations are *not* intended for use in the solution of most problems. The concepts and techniques are simple enough that it is good practice to start from the conservation of energy and derive the forces in each problem. In this way we can be certain that fundamental physical laws are satisfied.

Example 3.1.1. To illustrate the use of this technique consider again the electric field system that was treated earlier in Example 2.1.5 and represented by Fig. 2.1.8. That figure is reproduced here as Fig. 3.1.5 for convenience. The electrical terminal relations were derived in Example 2.1.5 and are expressible in the forms

$$v_1 = S_1(x_1, x_2)q_1 + S_m(x_1, x_2)q_2, \quad (a)$$

$$v_2 = S_m(x_1, x_2)q_1 + S_2(x_1, x_2)q_2, \quad (b)$$

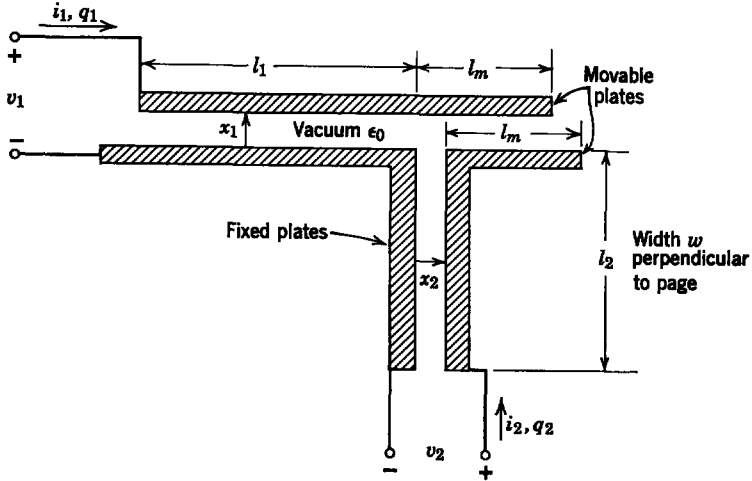

Fig. 3.1.5. Multiply excited electric field system.

where we have solved (a) and (b) of Example 2.1.5 for v_1 and v_2 , and therefore have

$$S_1 = \frac{C_2}{C_1 C_2 - C_m^2},$$

$$S_2 = \frac{C_1}{C_1 C_2 - C_m^2},$$

$$S_m = \frac{C_m}{C_1 C_2 - C_m^2};$$

C_1 , C_2 , and C_m are the functions of x_1 and x_2 given by (c), (d), and (e) of Example 2.1.5.

The system is first assembled mechanically with q_1 and q_2 zero, during which process no energy is put into the system. Next, charges q_1 and q_2 are brought to their final values with x_1 and x_2 fixed. This step requires an integration along a path in the q_1 - q_2 plane. The path chosen for this example is shown in Fig. 3.1.6. Along this path the running variables are related by

$$q'_2 = \frac{q_2}{q_1} q'_1;$$

thus the necessary integral takes the form

$$W_e(q_1, q_2, x_1, x_2) = \int_0^{q_1} \left[v_1 \left(q'_1, \frac{q_2}{q_1} q'_1, x_1, x_2 \right) dq'_1 + v_2 \left(q'_1, \frac{q_2}{q_1} q'_1, x_1, x_2 \right) \frac{q_2}{q_1} dq'_1 \right]. \quad (c)$$

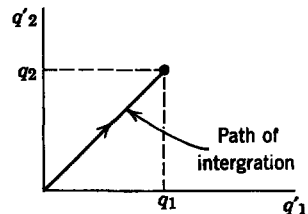

Fig. 3.1.6 Illustrating a path for line integration in variable space for Example 3.1.1.

Substitution of (a) and (b) into (c) and evaluation of the integral yields

$$W_e(q_1, q_2, x_1, x_2) = \frac{1}{2} S_1(x_1, x_2) q_1^2 + S_m(x_1, x_2) q_1 q_2 + \frac{1}{2} S_2(x_1, x_2) q_2^2. \quad (d)$$

From this expression we can now evaluate the mechanical forces of electric origin f_1^e and f_2^e (mechanical terminal relations); thus

$$f_1^e(q_1, q_2, x_1, x_2) = -\frac{\partial W_e}{\partial x_1} = -\frac{1}{2}q_1^2 \frac{\partial S_1}{\partial x_1} - q_1 q_2 \frac{\partial S_m}{\partial x_1} - \frac{1}{2}q_2^2 \frac{\partial S_2}{\partial x_1}, \quad (e)$$

$$f_2^e(q_1, q_2, x_1, x_2) = -\frac{\partial W_e}{\partial x_2} = -\frac{1}{2}q_1^2 \frac{\partial S_1}{\partial x_2} - q_1 q_2 \frac{\partial S_m}{\partial x_2} - \frac{1}{2}q_2^2 \frac{\partial S_2}{\partial x_2}. \quad (f)$$

Because S_1 , S_2 , and S_m are known as functions of x_1 and x_2 for this example, the derivatives in (e) and (f) can be calculated; this is straightforward differentiation, however, and is not carried out here.

3.1.2b Force-Coenergy Relations

So far in the magnetic field examples the flux linkage λ has been used as the independent variable, with current i described by the terminal relation. Similarly, in electric field examples charge q has been used as the independent variable, with voltage v described by the terminal relation. These choices were natural because of the form of the conservation of energy equations (3.1.9) and (3.1.13). Note that in Example 3.1.1 we were required to find $v_1(q_1, q_2)$ and $v_2(q_1, q_2)$. It would have been more convenient if we had been able to use $q_1(v_1, v_2)$ and $q_2(v_1, v_2)$, for this is the form these equations took in Example 2.1.5. We consider next how this can be done.

It should be possible to analyze systems using current as the independent electrical variable for magnetic field systems and voltage as the independent variable for electric field systems. In fact, it is often more convenient to make this choice. Alternatively, it is sometimes convenient to use a hybrid set of variables consisting of both currents and flux linkages in magnetic field systems and voltages and charges in electric field systems. Such hybrid sets of variables are used in Chapter 5.

To illustrate this change of independent variables consider once again the magnetic field system described in Fig. 3.1.1, with the restriction that the current i is to be used as the independent variable. The conservation of energy as expressed by (3.1.9) is still a fundamental relation:

$$dW_m = i d\lambda - f^e dx. \quad (3.1.9)$$

The electrical terminal relation is (3.1.1),

$$\lambda = \lambda(i, x), \quad (3.1.1)$$

and the mechanical terminal relation is (3.1.2),

$$f^e = f^e(i, x). \quad (3.1.2)$$

Equation 3.1.9 can be written in a form that involves di and dx by first using the rule of differentiation,

$$i d\lambda = d(\lambda i) - \lambda di. \quad (3.1.31)$$

Then the energy equation (3.1.9) is

$$dW'_m = \lambda di + f^e dx, \quad (3.1.32)$$

where

$$W'_m = \lambda i - W_m. \quad (3.1.33)$$

The energy equation (3.1.32) now has the required form in which changes in the function W'_m are accounted for by changes in the independent variables (i, x). The function $W'_m(i, x)$ is called the *coenergy* and is defined in terms of the energy $W_m(i, x)$ and terminal relations $\lambda(i, x)$ by (3.1.33).*

Remember that (3.1.32) physically represents conservation of energy for the coupling network. The form of this equation is similar to that of (3.1.9) and our arguments now parallel those of Section 3.1.2a. Because $W'_m = W'_m(i, x)$,

$$dW'_m = \frac{\partial W'_m}{\partial i} di + \frac{\partial W'_m}{\partial x} dx. \quad (3.1.34)$$

We subtract (3.1.34) from (3.1.32) to obtain

$$0 = \left(\lambda - \frac{\partial W'_m}{\partial i} \right) di + \left(f^e - \frac{\partial W'_m}{\partial x} \right) dx. \quad (3.1.35)$$

Because di and dx are independent (arbitrary),

$$\lambda = \frac{\partial W'_m(i, x)}{\partial i}, \quad (3.1.36)$$

$$f^e = \frac{\partial W'_m(i, x)}{\partial x}. \quad (3.1.37)$$

If the stored energy (hence coenergy) is known, the electrical and mechanical terminal relations can be calculated. Comparison of (3.1.37) and (3.1.23) shows the change in the form of the force expression when the electrical variable chosen as independent is changed from λ to i .

The result of (3.1.37) can be generalized to a system with any number of terminal pairs in a straightforward manner (see Table 3.1). For a magnetic field system with N electrical terminal pairs and M translational mechanical terminal pairs the conservation of energy equation becomes

$$dW_m = \sum_{j=1}^N i_j d\lambda_j - \sum_{j=1}^M f_j^e dx_j. \quad (3.1.38)$$

We now use the generalization of (3.1.31),

$$\sum_{j=1}^N i_j d\lambda_j = \sum_{j=1}^N d(i_j \lambda_j) - \sum_{j=1}^N \lambda_j di_j, \quad (3.1.39)$$

* This manipulation, which represents conservation of energy in terms of new independent variables, is called a Legendre transformation in classical mechanics and thermodynamics.

to replace the first term on the right-hand side of (3.1.38). Rearranging terms, we obtain

$$dW'_m = \sum_{j=1}^N \lambda_j di_j + \sum_{j=1}^M f_j^e dx_j, \quad (3.1.40)$$

where

$$W'_m = \sum_{j=1}^N i_j \lambda_j - W_m \quad (3.1.41)$$

and W'_m is the coenergy. The independent variables are $(i_1, i_2, \dots, i_N; x_1, x_2, \dots, x_M)$. We assume that the λ 's and W_m in (3.1.41) are written in terms of these variables, hence that W'_m is a function of these variables. Then

$$dW'_m = \sum_{j=1}^N \frac{\partial W'_m}{\partial i_j} di_j + \sum_{j=1}^M \frac{\partial W'_m}{\partial x_j} dx_j, \quad (3.1.42)$$

and when we subtract (3.1.42) from (3.1.40) and require that the coefficient of each di_j and each dx_j be zero

$$\lambda_j = \frac{\partial W'_m}{\partial i_j}; \quad j = 1, 2, \dots, N, \quad (3.1.43)$$

$$f_j^e = \frac{\partial W'_m}{\partial x_j}; \quad j = 1, 2, \dots, M. \quad (3.1.44)$$

This same process of generalization can be carried out for an electric field system (see Table 3.1); for instance, for the system of N electrical terminal pairs and M rotational mechanical terminal pairs for which the torque was found in (3.1.27) the use of the voltage as the independent variable instead of charge leads to the result

$$T_i^e = \frac{\partial W'_e(v_1, v_2, \dots, v_N; \theta_1, \theta_2, \dots, \theta_M)}{\partial \theta_i}, \quad (3.1.45)$$

where

$$W'_e = \sum_{j=1}^N v_j q_j - W_e. \quad (3.1.46)$$

This expression is obtained by a straightforward process of exactly the same form as that used for the general magnetic field system (3.1.38) to (3.1.44).

It is not necessary to find the coenergy by first determining the energy; for example, we can integrate (3.1.32) to find W'_m just as we integrated (3.1.9) to find W_m . In general, we evaluate W'_m by selecting a path of integration through variable space for (3.1.40) that changes the x_j 's with all electrical excitations zero and then changes electrical excitations with mechanical displacements held fixed.

For a better understanding of the meaning of coenergy consider the

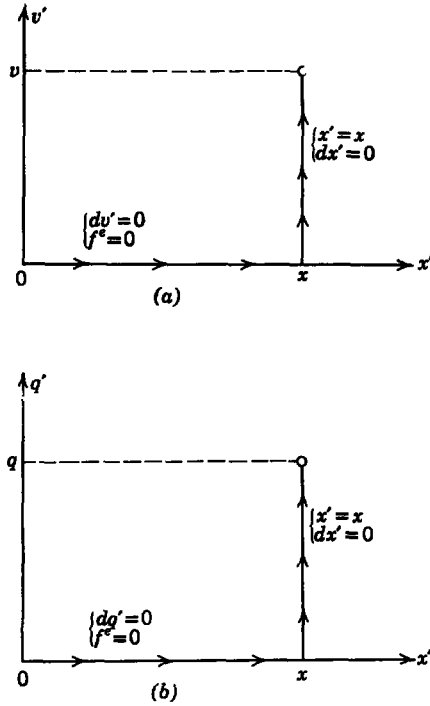

Fig. 3.1.7 Paths of integration in variable space: (a) for evaluating coenergy; (b) for evaluating energy.

simple electric field system presented earlier in Fig. 3.1.2. The coenergy is evaluated by the integration of

$$dW'_e = q dv + f^e dx. \quad (3.1.47)$$

[This is the energy equation (3.1.13) with $v dq = d(vq) - q dv$ and $W'_e = qv - W_e$.] We use the path of integration defined in Fig. 3.1.7a to reduce this integration to

$$W'_e = \int_0^v q(v', x) dv'. \quad (3.1.48)$$

In the case of electrical linearity

$$q(v, x) = C(x)v, \quad (3.1.49)$$

and (3.1.48) becomes

$$W'_e = \frac{1}{2}Cv^2. \quad (3.1.50)$$

It follows that

$$f^e = \frac{\partial W'_e(v, x)}{\partial x} = \frac{1}{2}v^2 \frac{dC}{dx}. \quad (3.1.51)$$

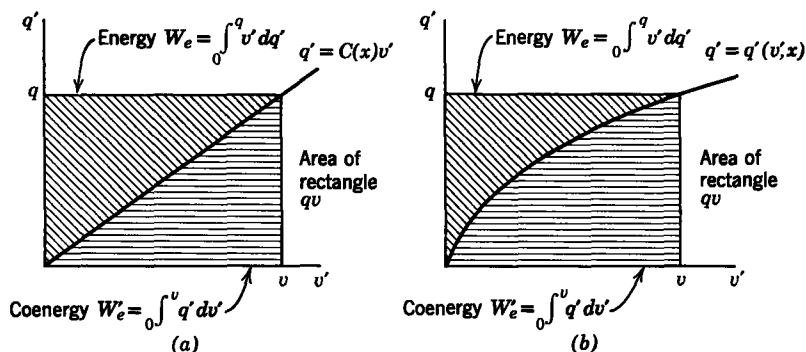

Fig. 3.1.8 Illustration of energy and coenergy: (a) electrically linear system; (b) electrically nonlinear system.

We can compare this result with what we find if we integrate (3.1.13) along the path of Fig. 3.1.7b to find the energy

$$W_e = \int_0^q v(q', x) dq', \quad (3.1.52)$$

which from (3.1.49) is

$$W_e(q, x) = \frac{q^2}{2C(x)}. \quad (3.1.53)$$

Now, when we use (3.1.49) to eliminate q from this expression, we see that the coenergy and energy are *numerically* equal. This is a consequence of the electrical linearity, as may be seen by observing Fig. 3.1.8a, in which (3.1.48) and (3.1.52) are the areas in the q' - v' plane indicated. (Remember that, by definition, in our system with one electrical terminal pair $W_e' + W_e = qv$.) When the areas are separated by a straight line (3.1.49), the integrals are obviously equal. On the other hand, when the areas are not separated by a straight line, the system is electrically nonlinear and energy and coenergy are not equal. An example of electrical nonlinearity is shown in Fig. 3.1.8b.

Energy and coenergy have the same numerical values in an electrically linear system. We have, however, consistently made use of the energy expressed as a function of (q, x) or (λ, x) and the coenergy expressed as a function of (v, x) or (i, x) . These functions are quite different in mathematical form, even when the system is electrically linear [compare (3.1.50) and (3.1.53)].

A word of caution is called for at this point. A partial derivative is taken with respect to one independent variable holding the other independent variables fixed. In order for this process to be correct, it is easiest to perform the differentiation when the function to be differentiated is written without explicit dependence on dependent variables. To be more specific, consider

the capacitance $C(x)$ of plane parallel plates with area A and spacing x (Fig. 3.1.2). Then

$$C(x) = \frac{A\epsilon}{x} \quad (3.1.54)$$

and (3.1.51) gives

$$f^e = -\frac{v^2 A \epsilon}{2x^2}. \quad (3.1.55)$$

The minus sign tells us that f^e acts on the upper plate (node) in the $(-x)$ direction. This we expect, for positive charges on the top plate are attracted by negative charges on the bottom plate. We can obtain the same result by using the energy and the translational form of (3.1.27).

$$f^e = -\frac{\partial W_e(q, x)}{\partial x}. \quad (3.1.56)$$

From (3.1.53) and (3.1.54)

$$f^e = -\frac{q^2}{2A\epsilon}. \quad (3.1.57)$$

In view of (3.1.49) and (3.1.54) this result and (3.1.55) are identical. Suppose, however, that we blindly apply (3.1.56) to the energy of (3.1.53) with q replaced by Cv . The magnitude of the resulting force will be correct, but the sign will be wrong. For electrically nonlinear systems the magnitude of the force will also be wrong if the partial differentiation is not carried out correctly.

The generalized force and coenergy equations are summarized in Table 3.1. This table is intended to illustrate the generality of the equations and their interrelations. The general equations are *not* recommended for use in solving problems. It is better to rederive the equations in each case to make certain that fundamental physical laws are satisfied. Equations (k) to (n) in Table 3.1 for evaluating energy and coenergy are written by using a path of integration that brings each electrical variable from zero to its final value in sequence $j = 1$ to $j = N$.

3.1.2c Reciprocity

The mathematical description of a conservative electromechanical coupling system must satisfy a *reciprocity* condition that is a generalization of the reciprocity conventionally discussed in electric circuit theory.* To illustrate reciprocity for a simple example, consider the magnetic field system of Fig. 3.1.1 for which the terminal relations are expressed as derivatives of stored

* E. A. Guillemin, *Introductory Circuit Theory*, Wiley, New York, 1953, pp. 148–150 and 429.

energy in (3.1.22) and (3.1.23):

$$i = \frac{\partial W_m(\lambda, x)}{\partial \lambda}, \quad (3.1.22)$$

$$f^e = -\frac{\partial W_m(\lambda, x)}{\partial x}. \quad (3.1.23)$$

We now differentiate (3.1.22) with respect to x and (3.1.23) with respect to λ . Then, because

$$\frac{\partial^2 W_m}{\partial \lambda \partial x} = \frac{\partial^2 W_m}{\partial x \partial \lambda},$$

the reciprocity relation results:

$$\frac{\partial i(\lambda, x)}{\partial x} = -\frac{\partial f^e(\lambda, x)}{\partial \lambda}. \quad (3.1.58)$$

The process used in obtaining the reciprocity condition (3.1.58) shows that the condition is necessary for the system to be conservative. This same condition can also be shown to be sufficient to ensure that the system is conservative. The proof requires a straightforward but involved integration and is not carried out here primarily because it is a standard inclusion in some thermodynamics texts.*

The reciprocity condition of (3.1.58) can be generalized to describe a conservative system with any number of terminal pairs. Consider again the electric-field system with N electrical terminal pairs and M rotational mechanical terminal pairs whose terminal relations are described by (3.1.26) and (3.1.27):

$$v_i = \frac{\partial W_e}{\partial q_i}; \quad i = 1, 2, \dots, N, \quad (3.1.26)$$

$$T_i^e = -\frac{\partial W_e}{\partial \theta_i}; \quad i = 1, 2, \dots, M. \quad (3.1.27)$$

When we take appropriate partial derivatives of these equations and recognize that the order of differentiation is immaterial, we obtain the general reciprocity conditions:

$$\frac{\partial v_i}{\partial q_j} = \frac{\partial v_j}{\partial q_i}, \quad i, j = 1, 2, \dots, N, \quad (3.1.59)$$

$$\frac{\partial T_i^e}{\partial \theta_j} = \frac{\partial T_j^e}{\partial \theta_i}, \quad i, j = 1, 2, \dots, M, \quad (3.1.60)$$

$$\frac{\partial v_i}{\partial \theta_j} = -\frac{\partial T_j^e}{\partial q_i}; \quad i = 1, 2, \dots, N, \quad (3.1.61)$$

$$j = 1, 2, \dots, M.$$

* See, for instance, W. P. Allis and M. A. Herlin, *Thermodynamics and Statistical Mechanics*, McGraw-Hill, 1952, pp. 6-9.

Note that for an electrically linear system (3.1.59) reduces to $C_{ij} = C_{ji}$ which is the usual form of the reciprocity relation for linear capacitive circuits.*

Although the reciprocity conditions must always be satisfied for a conservative system, they are not often used in the analysis and design of electromechanical systems. Their primary usefulness is twofold. First, they provide a rapid check on results to identify certain kinds of mathematical error; and, second, they provide a mathematical framework for identifying the classes of nonlinear functions with which we can approximate the terminal relations of multiterminal-pair, electrically nonlinear, systems. If the reciprocity conditions are not satisfied, the mathematical description will imply sources and/or sinks of energy in the coupling field that can lead to nonphysical results.

3.1.3 Energy Conversion

The fact that in lumped-parameter electromechanics we are dealing with lossless coupling systems in which stored energy is a state function (single-valued function of the independent variables) can be quite useful in assessing energy conversion properties of electromechanical systems. This is especially true of systems that operate cyclically. For any conservative coupling system we can write the conservation of energy as

$$\left[\begin{array}{c} \text{electrical energy} \\ \text{input} \end{array} \right] + \left[\begin{array}{c} \text{mechanical energy} \\ \text{input} \end{array} \right] = \left[\begin{array}{c} \text{change in} \\ \text{stored energy} \end{array} \right]. \quad (3.1.62)$$

For a complete cycle of operation, that is, for a situation in which the independent variables return to the values from which they started, the net change in stored energy is zero. Thus for a cyclic process (3.1.62) becomes

$$\left[\begin{array}{c} \text{net electrical} \\ \text{energy input} \\ \text{for one cycle} \end{array} \right] + \left[\begin{array}{c} \text{net mechanical} \\ \text{energy input} \\ \text{for one cycle} \end{array} \right] = 0. \quad (3.1.63)$$

We need to calculate only the electrical or mechanical energy input to find the net conversion of energy between electrical and mechanical forms.

Example 3.1.2. The device shown schematically in Fig. 3.1.9 is used to illustrate the energy conversion properties of a cyclically operating system.† It contains a cylindrical stator of highly permeable magnetic material with polar projections on which coils are wound. The two coils are connected in series in the polarity shown to form one electrical terminal pair. This machine also contains a rotor, made of highly permeable magnetic

* Guillemin, *loc. cit.*

† For more detail on this type of machine (called a two-pole, single-phase, salient-pole synchronous machine) see Section 4.2.

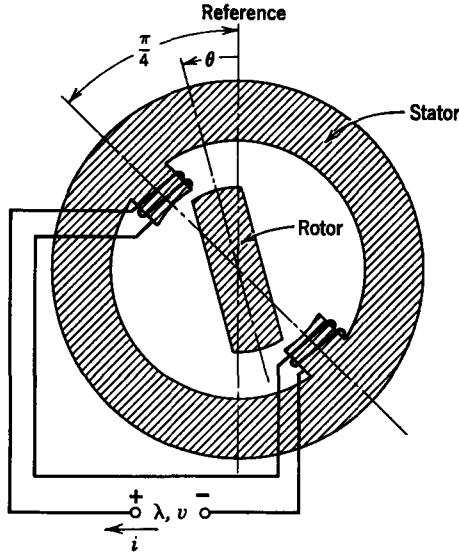

Fig. 3.1.9 A rotational magnetic field transducer.

material, which has the shape shown in end view in Fig. 3.1.9 and which can rotate about the axis with the instantaneous angle θ .

It is determined experimentally that the machine is electrically linear and that the electrical terminal relation can be approximated by the inductance

$$L = L_0 + L_2 \sin 2\theta, \tag{a}$$

where L_0 and L_2 are positive constants and $L_0 > L_2$. Note that this inductance is a maximum at $\theta = \pi/4$ and $\theta = 5\pi/4$, as we expected, because the air gaps between rotor and stator iron are smallest for these angles. Also, the inductance is a minimum for $\theta = -\pi/4$ and $\theta = 3\pi/4$, in which case the air gaps are largest. In practice, the rotor and stator are shaped so that the periodic variation of inductance with angle closely approaches the ideal of (a).

With the inductance thus specified, we can write the electrical terminal relation as

$$\lambda = Li = (L_0 + L_2 \sin 2\theta)i. \tag{b}$$

We can now use (b) to evaluate the magnetic coenergy by using (m) of Table 3.1,

$$W'_m = \frac{1}{2}(L_0 + L_2 \sin 2\theta)i^2, \tag{c}$$

and (g) in Table 3.1 to find the torque of electric origin,

$$T^e = \frac{\partial W'_m}{\partial \theta} = L_2 i^2 \cos 2\theta. \tag{d}$$

We can now represent the electromechanical coupling symbolically, as in Fig. 3.1.10. The box includes only the magnetic field energy storage of the machine. All purely electrical properties (winding resistance and losses in the magnetic material) and all purely mechanical properties (moment of inertia and friction) can be represented as lumped elements connected externally to the terminals of the coupling system.

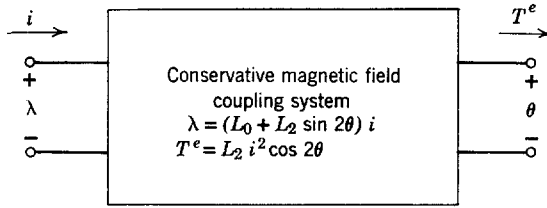

Fig. 3.1.10 Representation of the coupling field of the system in Fig. 3.1.9.

In an actual application there would be lumped electrical and mechanical elements, in addition to those inherent in the machine, connected to the coupling network. Our purpose here is to study the energy conversion properties of the coupling system; consequently, we will excite the terminals with ideal sources and there will be no need to consider passive elements connected to the terminals.

We now excite the electrical terminal pair of the coupling system with a sinusoidal current source

$$i = I \cos \omega t \tag{e}$$

and the mechanical terminal pair with the position source

$$\theta = \omega t, \tag{f}$$

where ω is a positive constant. With these terminal constraints and with steady-state operation, we wish to calculate the electromechanical energy conversion per cycle of operation.

Because they are constrained independently, current i and angle θ are the logical choices as independent variables. We can sketch the path of operation for one cycle in the i - θ plane, as shown in Fig. 3.1.11. Note that $\theta = 0$ and $\theta = 2\pi$ represent the same geometry; thus, although the trajectory in Fig. 3.1.11 does not close on itself, it nonetheless represents one cycle of operation in which the final physical state is the same as the initial physical state. The arrows indicate the direction that the operating point travels in the i - θ plane.

When we apply (3.1.63) to this system for a complete cycle of operation, we obtain,

$$\oint i \, d\lambda - \oint T^e \, d\theta = 0, \tag{g}$$

wherein \oint indicates an integral around a closed cycle. The first term represents the net

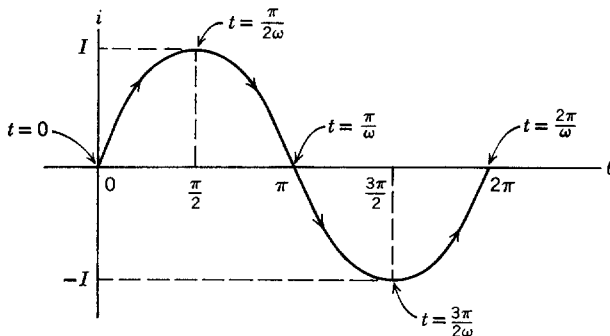

Fig. 3.1.11 Trajectory of operating point in i - θ plane.

electrical energy input over a cycle and the second (with the minus sign) represents the net mechanical energy input. Because there is no net change in stored energy, we need to calculate only the first or second term to find energy converted. To be thorough in our study we shall consider both terms.

We first look at the trajectory of the operating point in a λ - i plane. We can express it as two parametric equations (time is the parameter) by using (b) and (e):

$$\lambda = I(L_0 + L_2 \sin 2\omega t) \cos \omega t, \quad (h)$$

$$i = I \cos \omega t. \quad (i)$$

Alternatively, we can use trigonometric identities* to eliminate t from the two equations and obtain

$$\lambda = i \left[L_0 \pm \frac{2L_2 i}{I} \left(1 - \frac{i^2}{I^2} \right)^{1/2} \right]. \quad (j)$$

The double-valued character of this equation makes it easier to plot the trajectory by using the parametric equations (h) and (i). This trajectory is shown in Fig. 3.1.12, plotted for the relative parameter values

$$L_2 = \frac{1}{2}L_0.$$

Next, we can look at the trajectory of the operating point in the T^θ - θ plane. We use (d), (e), and (f) to write

$$T^\theta = L_2 I^2 \cos^2 \theta \cos 2\theta. \quad (k)$$

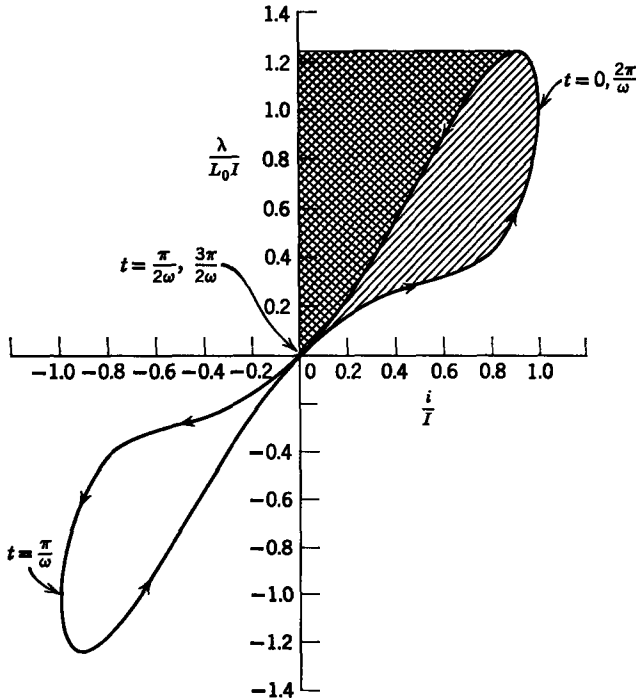

Fig. 3.1.12 Trajectory of operation in the λ - i plane for $L_2 = \frac{1}{2}L_0$.

* $\sin 2\omega t = 2 \sin \omega t \cos \omega t$; $\sin \omega t = \pm \sqrt{1 - \cos^2 \omega t}$.

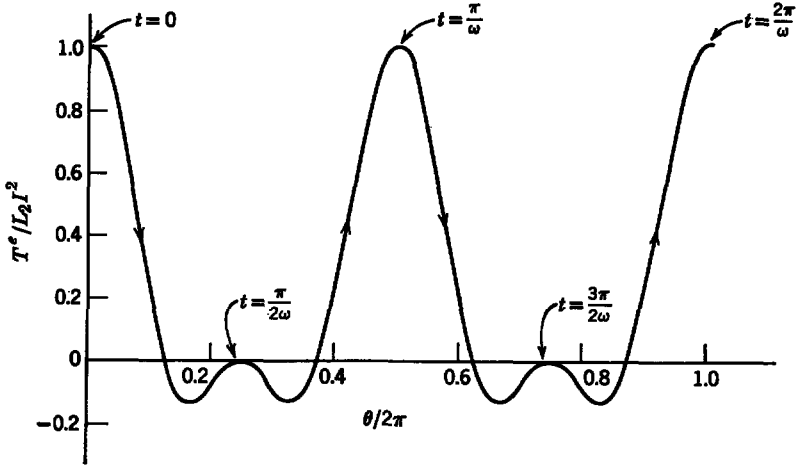

Fig. 3.1.13 Trajectory of operating point in T^e - θ plane.

This trajectory is shown in Fig. 3.1.13. Note once again that although the curve does not close on itself it represents a full cycle of operation because $\theta = 0$ and $\theta = 2\pi$ represent the same state. The direction of travel of the operating point is indicated on the curve.

We can now calculate the energy converted per cycle. First, evaluating

$$\oint i \, d\lambda = \text{net electrical input power,}$$

we can see graphically in Fig. 3.1.12 that the integral of $i \, d\lambda$ around the trajectory yields the area enclosed by the loop; furthermore, this area is positive. There is net conversion of energy from electrical to mechanical form. Under these conditions the machine is operating as a motor.

We can evaluate the energy converted per cycle by calculating the area enclosed by the loop in the first quadrant of Fig. 3.1.12 and multiplying the answer by two. This integral can best be performed parametrically by writing

$$i = I \cos \theta,$$

$$\lambda = I(L_0 + L_2 \sin 2\theta) \cos \theta,$$

$$d\lambda = (-IL_0 \sin \theta + 2L_2 I \cos 2\theta \cos \theta - L_2 I \sin 2\theta \sin \theta) \, d\theta.$$

Some trigonometric manipulation allows us to put $d\lambda$ in the form

$$d\lambda = I(-L_0 \sin \theta - 2L_2 \cos \theta + 4L_2 \cos^3 \theta - 2L_2 \cos \theta \sin^2 \theta) \, d\theta.$$

We can now write for the area of the loop in the first quadrant of Fig. 3.1.12

$$\begin{aligned} \frac{W_c}{2} &= \int_{-\pi/2}^{\pi/2} i(\theta) \, d\lambda(\theta) = \int_{-\pi/2}^{\pi/2} I^2 (-L_0 \sin \theta \cos \theta - 2L_2 \cos^2 \theta + 4L_2 \cos^4 \theta \\ &\quad - 2L_2 \cos^2 \theta \sin^2 \theta) \, d\theta, \end{aligned}$$

where W_c is the energy converted per cycle. Evaluation of this integral yields

$$W_c = \frac{\pi}{2} L_2 I^2.$$

We can also calculate the mechanical output energy per cycle from

$$\int_0^{2\pi} T^e d\theta = \int_0^{2\pi} L_2 I^2 \cos^2 \theta \cos 2\theta d\theta = \frac{\pi}{2} L_2 I^2,$$

which is equal to the electric input energy per cycle as it should be.

The ideas of energy bookkeeping illustrated by Example 3.1.2 can be extended to systems with arbitrary numbers of terminal pairs. For more than two variables the graphical representation of operation in variable space (Fig. 3.1.11) is difficult; it is possible, however, to represent the path of operation at each terminal pair (Figs. 3.1.12 and 3.1.13). Such techniques are especially suitable for systems that operate cyclically.

3.2 EQUATIONS OF MOTION

In the preceding sections of this chapter we have described in detail the various elements that make up lumped-parameter electromechanical systems. Our approach is to isolate the coupling system (either electric or magnetic field) and analyze its properties. We can then write Kirchhoff's laws for the electrical parts of the system by introducing electromechanical coupling effects through the terminal relations of the coupling system. Similarly, we write Newton's second law and continuity of space for the mechanical parts of the system, including electromechanical coupling effects in the terminal relations of the coupling system. We now present examples in which our objective is to write the complete equations of motion for electromechanical systems.

Example 3.2.1. We consider again the magnetic field system shown in Fig. 3.2.1. The electrical terminal relation of the coupling system was calculated in Example 2.1.1. Now we include the type of electrical and mechanical elements that will normally be present in applications of this transducer. The resistance R represents the winding resistance plus any additional series resistance in the external circuit. This system is of the form conventionally used to actuate relays, valves, etc.; consequently, the source $v_s(t)$ is usually a positive or negative step. The spring K is used to open the gap x to its maximum width when the current is zero. The linear damper B represents friction between the nonmagnetic sleeve and the plunger, although in some cases additional damping is added externally either to slow down the mechanical motion (as in a time-delay relay) or to reduce the bouncing that may occur when the plunger reaches $x = 0$.

In Example 2.1.1, with suitable assumptions, the flux linkages of this device were calculated to be

$$\lambda = \frac{L_0 i}{1 + x/g}, \quad (\text{a})$$

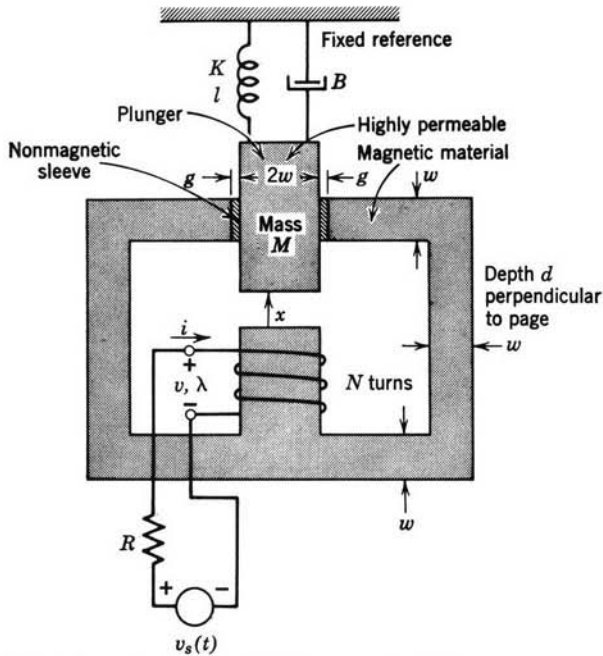

Fig. 3.2.1 A magnetic field electromechanical system.

where $L_0 = 2wd\mu_0 N^2/g$ is the coil inductance with the variable gap closed ($x = 0$). We wish to write the complete equations of motion.

We have a single electrical loop and a single mechanical node; consequently, we can write two equations in which the current i and displacement x are the dependent variables.

Applying Kirchhoff's voltage law to the electrical loop and using the terminal voltage of the coupling system as derived in Example 2.1.1, we obtain

$$v_s(t) = iR + \frac{L_0}{1 + x/g} \frac{di}{dt} - \frac{L_0}{g(1 + x/g)^2} \frac{dx}{dt}. \quad (b)$$

To write Newton's second law for the mechanical node we need the force of electric origin. We first write the magnetic coenergy [see (m) in Table 3.1] as

$$W'_m = \int_0^i \lambda(i', x) di'$$

and use (a) to write

$$W'_m = \frac{1}{2} \frac{L_0 i^2}{1 + x/g} \quad (c)$$

We now find the force by using (g) in Table 3.1.

$$f^e = -\frac{1}{2} \frac{L_0 i^2}{g(1 + x/g)^2}. \quad (d)$$

This is a force source applied to the mechanical node x .

We can now write Newton's law for the mechanical node as

$$-\frac{1}{2} \frac{L_0 i^2}{g(1+x/g)^2} = M \frac{d^2 x}{dt^2} + B \frac{dx}{dt} + K(x-l). \quad (e)$$

Equations b and e are the equations of motion for this system. Note that there are two equations with two dependent variables (unknowns) i and x . The driving function is the source voltage $v_s(t)$. If we specify the explicit variation of v_s with time and also specify initial conditions, we, at least in theory, can solve (b) and (e) for i and x . The dynamic behavior of this system is studied in Section 5.1.2.

In the above analysis no account has been taken of the two mechanical stops that limit the mechanical motion. It is easiest to include them as position sources; in practical cases, however, the stops may also have some elastic effects that result in bouncing of the plunger at the ends of its travel. If such effects are important, they can be included in a straightforward manner.

Example 3.2.2. In this example we wish to consider a system with more than one electrical terminal pair and more than one mechanical node. For this purpose we use the basic electric field coupling system of Example 2.1.5, shown in Fig. 3.2.2, along with suitable external electrical and mechanical elements.

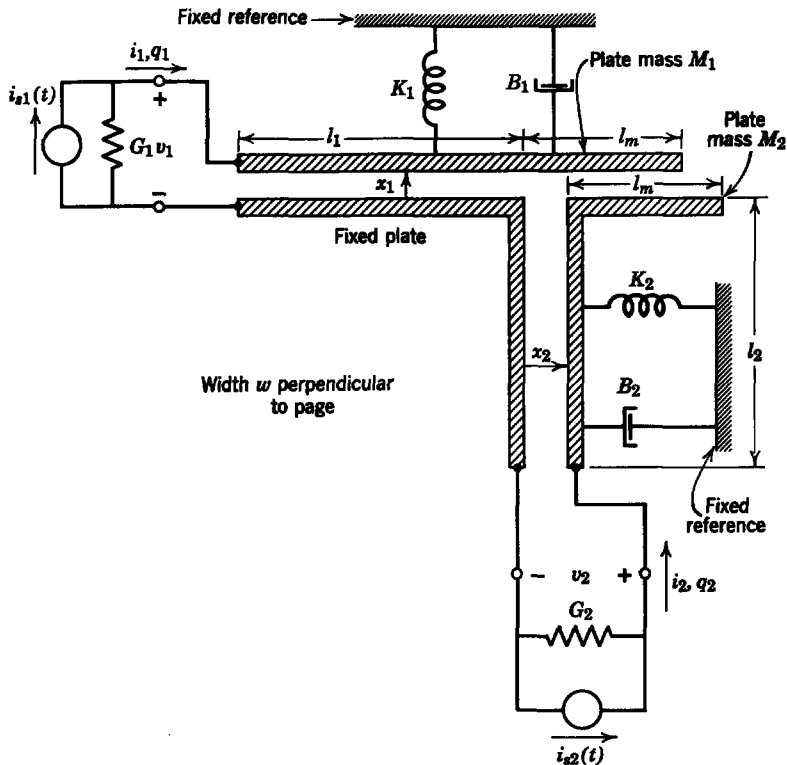

Fig. 3.2.2 Multiply excited electric field-coupled electromechanical system.

The electrical terminal relations were derived for this system in Example 2.1.5 and are

$$q_1 = C_1 v_1 - C_m v_2, \quad (a)$$

$$q_2 = -C_m v_1 + C_2 v_2, \quad (b)$$

where

$$C_1 = \frac{\epsilon_0 w [l_1 + (l_m - x_2)]}{x_1}, \quad (c)$$

$$C_2 = \epsilon_0 w \left(\frac{l_2}{x_2} + \frac{l_m - x_2}{x_1} \right), \quad (d)$$

$$C_m = \frac{\epsilon_0 w (l_m - x_2)}{x_1}. \quad (e)$$

We write Kirchoff's current law for the two electrical nodes as

$$i_{s1}(t) = G_1 v_1 + \frac{dq_1}{dt}, \quad (f)$$

$$i_{s2}(t) = G_2 v_2 + \frac{dq_2}{dt}. \quad (g)$$

Using (a) to (e), we express these equations explicitly in terms of the unknowns as

$$i_{s1}(t) = G_1 v_1 + \frac{\epsilon_0 w [l_1 + (l_m - x_2)]}{x_1} \frac{dv_1}{dt} - \frac{\epsilon_0 w (l_m - x_2)}{x_1} \frac{dv_2}{dt} \\ - \frac{\epsilon_0 w [l_1 + (l_m - x_2)]}{x_1^2} v_1 \frac{dx_1}{dt} - \frac{\epsilon_0 w}{x_1} v_1 \frac{dx_2}{dt} + \frac{\epsilon_0 w (l_m - x_2)}{x_1^2} v_2 \frac{dx_1}{dt} + \frac{\epsilon_0 w}{x_1} v_2 \frac{dx_2}{dt} \quad (h)$$

$$i_{s2}(t) = G_2 v_2 - \frac{\epsilon_0 w (l_m - x_2)}{x_1} \frac{dv_1}{dt} + \epsilon_0 w \left(\frac{l_2}{x_2} + \frac{l_m - x_2}{x_1} \right) \frac{dv_2}{dt} + \frac{\epsilon_0 w (l_m - x_2)}{x_1^2} v_1 \frac{dx_1}{dt} \\ + \frac{\epsilon_0 w}{x_1} v_1 \frac{dx_2}{dt} - \frac{\epsilon_0 w (l_m - x_2)}{x_1^2} v_2 \frac{dx_1}{dt} - \epsilon_0 w \left(\frac{l_2}{x_2^2} + \frac{1}{x_1} \right) v_2 \frac{dx_2}{dt}. \quad (i)$$

Before we can write equations for the mechanical nodes we must calculate the forces of electric origin. Because we want the explicit electrical variables to be the voltages, we use (n) in Table 3.1 to evaluate the coenergy as

$$W'_e = \frac{1}{2} C_1 v_1^2 + C_m v_1 v_2 + \frac{1}{2} C_2 v_2^2. \quad (j)$$

We now use (h) in Table 3.1 to evaluate the forces

$$f_1^e = \frac{\partial W'_e}{\partial x_1} = \frac{1}{2} v_1^2 \frac{\partial C_1}{\partial x_1} + v_1 v_2 \frac{\partial C_m}{\partial x_1} + \frac{1}{2} v_2^2 \frac{\partial C_2}{\partial x_1}, \quad (k)$$

$$f_2^e = \frac{\partial W'_e}{\partial x_2} = \frac{1}{2} v_1^2 \frac{\partial C_1}{\partial x_2} + v_1 v_2 \frac{\partial C_m}{\partial x_2} + \frac{1}{2} v_2^2 \frac{\partial C_2}{\partial x_2}. \quad (l)$$

We carry out the indicated differentiations and include these two forces as sources in writing Newton's second law for the two mechanical nodes.

$$\begin{aligned}
 -\frac{1}{2}v_1^2 \frac{\epsilon_0 w [l_1 + (l_m - x_2)]}{x_1^2} - v_1 v_2 \frac{\epsilon_0 w (l_m - x_2)}{x_1^2} - \frac{1}{2}v_2^2 \frac{\epsilon_0 w (l_m - x_2)}{x_1^2} \\
 = M_1 \frac{d^2 x_1}{dt^2} + B_1 \frac{dx_1}{dt} + K_1 x_1, \quad (m)
 \end{aligned}$$

$$-\frac{1}{2}v_1^2 \frac{\epsilon_0 w}{x_1} - v_1 v_2 \frac{\epsilon_0 w}{x_1} - \frac{1}{2}v_2^2 \epsilon_0 w \left(\frac{l_2}{x_2^2} + \frac{1}{x_1} \right) = M_2 \frac{d^2 x_2}{dt^2} + B_2 \frac{dx_2}{dt} + K_2 x_2. \quad (n)$$

Equations (h), (i), (m), and (n) are the four equations of motion for the system in Fig. 3.2.2. Several important aspects of these equations should be examined. First, we note that all four equations are coupled, that is, each equation contains all four dependent variables. We also note that there is no external coupling between electrical terminal pairs and between mechanical terminal pairs; thus all the coupling occurs through the electric fields. We note further that the coupling between the two mechanical terminal pairs [see (m) and (n)] results in terms that are functions of mechanical positions and voltages. Thus these coupling terms appear essentially as nonlinear elements whose properties depend on the electrical variables (voltages).

3.3 DISCUSSION

In this chapter we have learned some of the general properties of conservative electromechanical coupling networks. In the process we have indicated techniques for finding mechanical forces of electric origin once electrical terminal relations are known. We have also introduced techniques for studying the energy conversion properties of coupling fields and illustrated the method of writing complete equations of motion for electromechanical systems. In Chapter 5 we complete our study of lumped-parameter electromechanical systems by introducing techniques for solving the equations of motion and by emphasizing some of the more important phenomena that occur in these systems.