

MIT OpenCourseWare
<http://ocw.mit.edu>

6.641 Electromagnetic Fields, Forces, and Motion
Spring 2009

For information about citing these materials or our Terms of Use, visit: <http://ocw.mit.edu/terms>.

6.641, Electromagnetic Fields, Forces, and Motion
 Prof. Markus Zahn
Lecture 7: Polarization and Conduction

I. Experimental Observation

A. Fixed Voltage - Switch Closed ($v = V_0$)

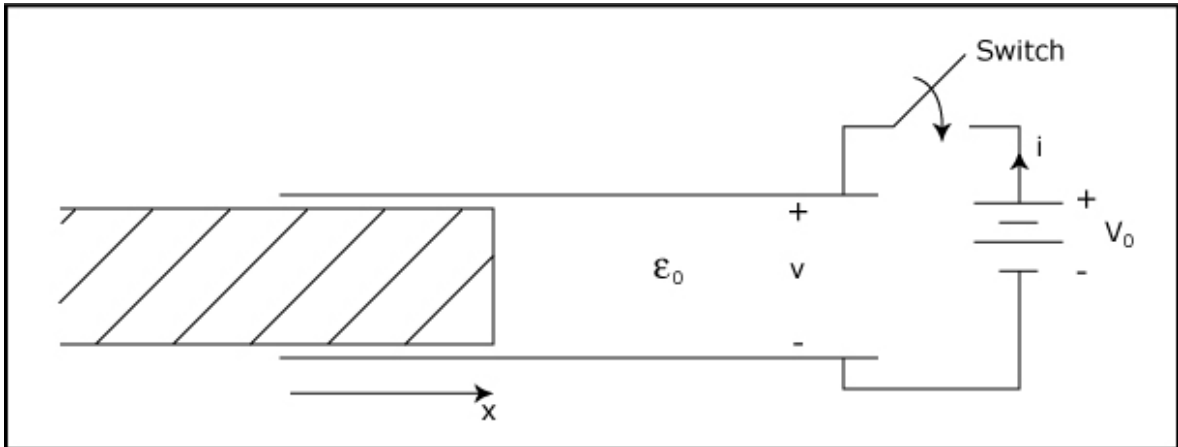

As an insulating material enters a free-space capacitor at constant voltage more charge flows onto the electrodes; i.e. as x increases, i increases.

B. Fixed Charge - Switch open ($i=0$)

As an insulating material enters a free space capacitor at constant charge, the voltage decreases; i.e. as x increases, v decreases.

II. Dipole Model of Polarization

A. Polarization Vector $\bar{P} = N\bar{p} = Nq\bar{d}$ ($\bar{p} = q\bar{d}$ dipole moment)

N dipoles/Volume (\bar{P} is dipole density)

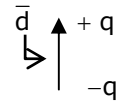

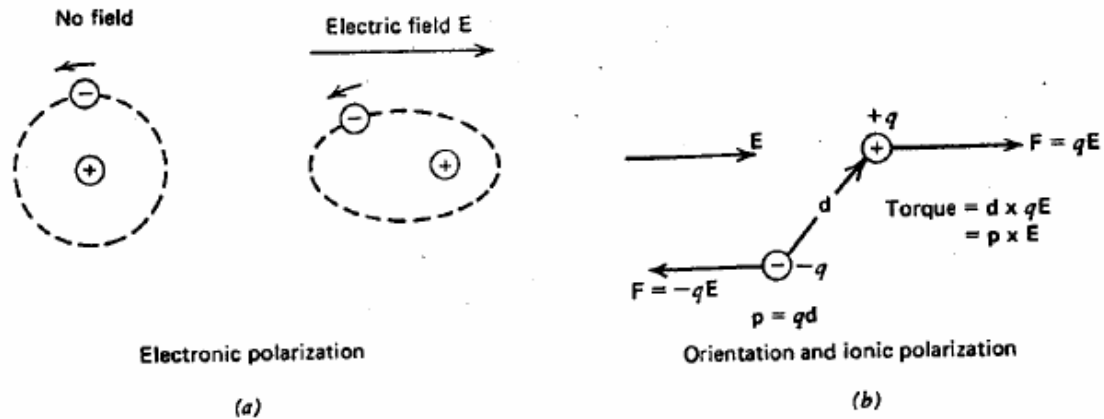
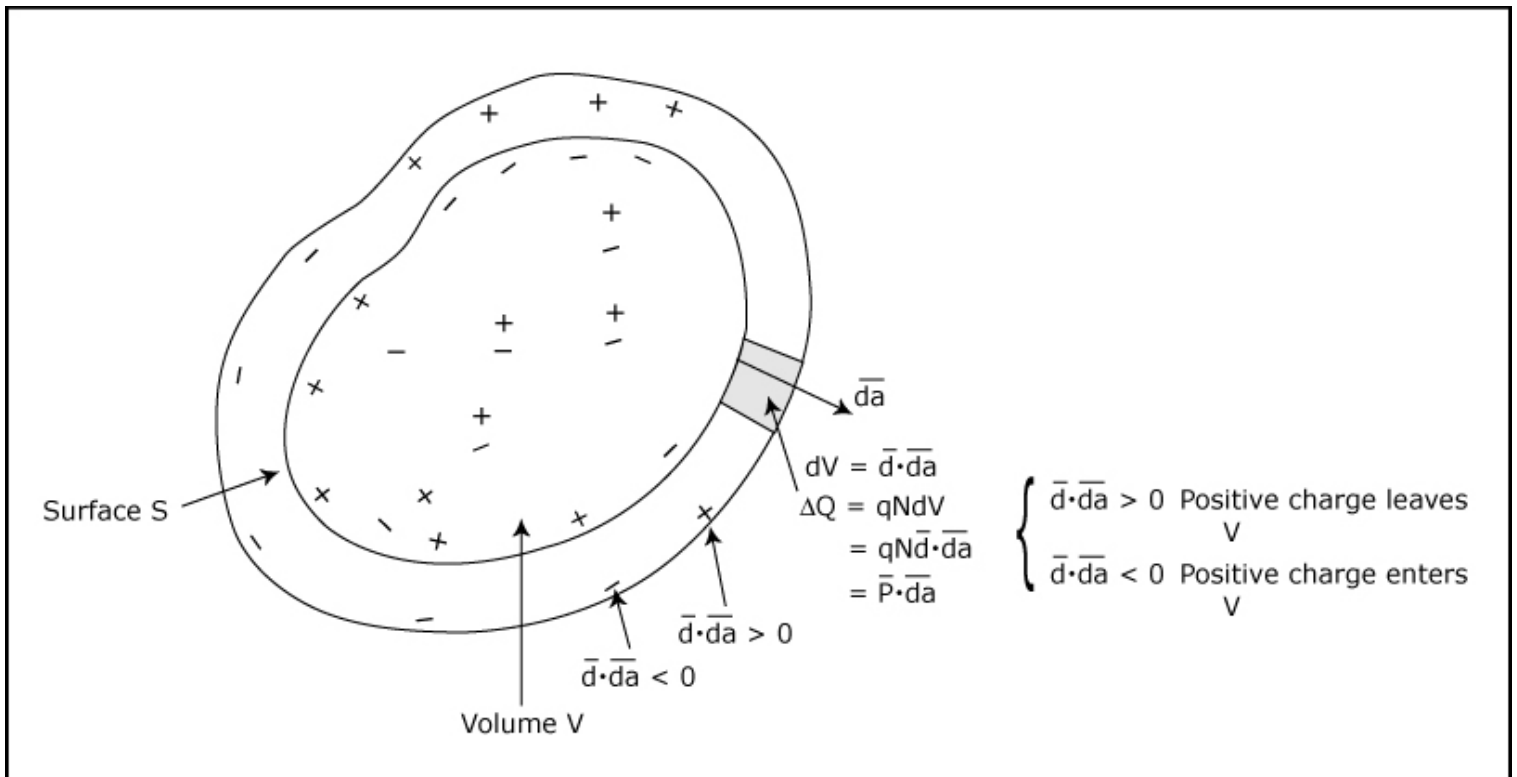

Figure 3-1 An electric dipole consists of two charges of equal magnitude but opposite sign, separated by a small vector distance d . (a) Electronic polarization arises when the average motion of the electron cloud about its nucleus is slightly displaced. (b) Orientation polarization arises when an asymmetric polar molecule tends to line up with an applied electric field. If the spacing d also changes, the molecule has ionic polarization.



$$Q_{\text{inside } V} = -\oint_S q N \bar{d} \cdot \bar{d}a = \int_V \rho_p dV$$

paired charge or
equivalently
polarization
charge density

$$Q_{\text{inside } V} = -\oint_S \bar{P} \cdot \bar{d}a = -\int_V \nabla \cdot \bar{P} dV = \int_V \rho_p dV \quad (\text{Divergence Theorem})$$

$$\bar{P} = q N \bar{d}$$

$$\nabla \cdot \bar{P} = -\rho_p$$

B. Gauss' Law

$$\nabla \cdot (\epsilon_0 \bar{E}) = \rho_{\text{total}} = \rho_u + \rho_p = \rho_u - \nabla \cdot \bar{P}$$

↖

unpaired charge
density; also
called free charge
density

$$\nabla \cdot (\epsilon_0 \bar{E} + \bar{P}) = \rho_u$$

$$\bar{D} = \epsilon_0 \bar{E} + \bar{P} \quad \text{Displacement Flux Density}$$

$$\nabla \cdot \bar{D} = \rho_u$$

C. Boundary Conditions

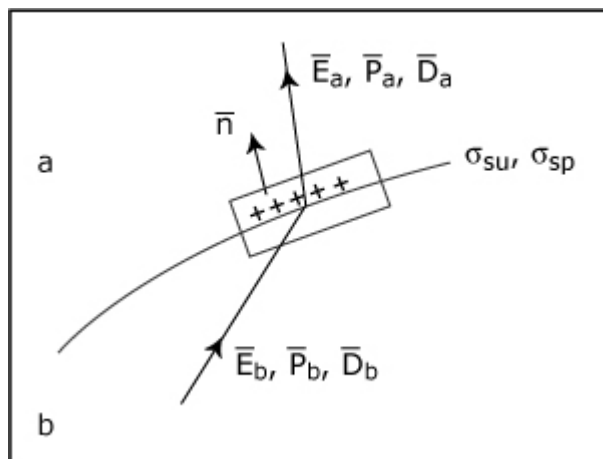

$$\nabla \cdot \bar{D} = \rho_u \Rightarrow \oint_S \bar{D} \cdot \overline{d\mathbf{a}} = \int_V \rho_u dV \Rightarrow \bar{n} \cdot [\bar{D}_a - \bar{D}_b] = \sigma_{su}$$

$$\nabla \cdot \bar{P} = -\rho_p \Rightarrow \oint_S \bar{P} \cdot \overline{d\mathbf{a}} = -\int_V \rho_p dV \Rightarrow \bar{n} \cdot [\bar{P}_a - \bar{P}_b] = -\sigma_{sp}$$

$$\nabla \cdot (\epsilon_0 \bar{E}) = \rho_u + \rho_p \Rightarrow \oint_S \epsilon_0 \bar{E} \cdot \overline{d\mathbf{a}} = \int_V (\rho_u + \rho_p) dV \Rightarrow \bar{n} \cdot \epsilon_0 [\bar{E}_a - \bar{E}_b] = \sigma_{su} + \sigma_{sp}$$

D. Polarization Current Density

$$\Delta Q = qN dV = qN \bar{d} \cdot \overline{d\mathbf{a}} = \bar{P} \cdot \overline{d\mathbf{a}}$$

[Amount of Charge passing through surface area element $\overline{d\mathbf{a}}$]

$$di_p = \frac{\partial \Delta Q}{\partial t} = \frac{\partial \bar{P}}{\partial t} \cdot \overline{d\mathbf{a}}$$

[Current passing through surface area element $\overline{d\mathbf{a}}$]

$$= \bar{J}_p \cdot \overline{d\mathbf{a}}$$

polarization current density

$$\bar{J}_p = \frac{\partial \bar{P}}{\partial t}$$

Ampere's law:

$$\nabla \times \bar{H} = \bar{J}_u + \bar{J}_p + \epsilon_0 \frac{\partial \bar{E}}{\partial t}$$

$$= \bar{J}_u + \frac{\partial \bar{P}}{\partial t} + \epsilon_0 \frac{\partial \bar{E}}{\partial t}$$

$$= \bar{J}_u + \frac{\partial}{\partial t} (\epsilon_0 \bar{E} + \bar{P})$$

$$= \bar{J}_u + \frac{\partial \bar{D}}{\partial t}$$

III. Equipotential Sphere in a Uniform Electric Field

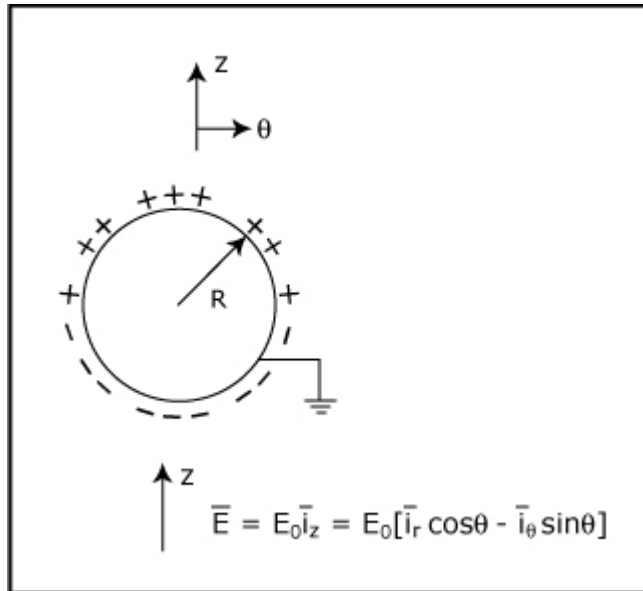

$$\lim_{r \rightarrow \infty} \Phi(r, \theta) = -E_0 r \cos \theta \quad [\Phi = -E_0 z = -E_0 r \cos \theta]$$

$$\Phi(r = R, \theta) = 0$$

$$\Phi(r, \theta) = -E_0 \left[r - \frac{R^3}{r^2} \right] \cos \theta$$

This solution is composed of the superposition of a uniform electric field plus the field due to a point electric dipole at the center of the sphere:

$$\Phi_{\text{dipole}} = \frac{p \cos \theta}{4\pi\epsilon_0 r^2} \quad \text{with } p = 4\pi\epsilon_0 E_0 R^3$$

This dipole is due to the surface charge distribution on the sphere.

$$\begin{aligned} \sigma_s(r = R, \theta) &= \epsilon_0 E_r(r = R, \theta) = -\epsilon_0 \left. \frac{\partial \Phi}{\partial r} \right|_{r=R} = \epsilon_0 E_0 \left[1 + \frac{2R^3}{r^3} \right]_{r=R} \cos \theta \\ &= 3\epsilon_0 E_0 \cos \theta \end{aligned}$$

IV. Artificial Dielectric

$$E = \frac{V}{d}, \quad \sigma_s = \epsilon E = \frac{\epsilon V}{d}$$

$$q = \sigma_s A = \frac{\epsilon A}{d} V$$

$$C = \frac{q}{V} = \frac{\epsilon A}{d}$$

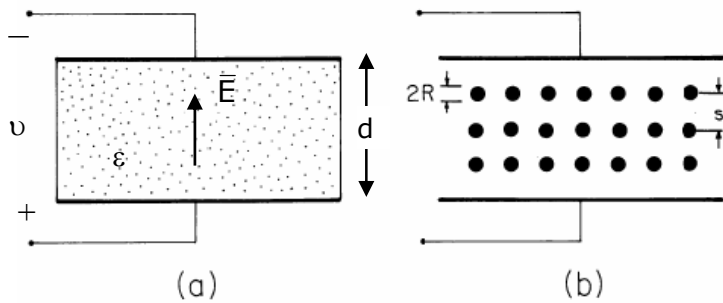

Figure 6.6.1 (a) Plane parallel capacitor with region between electrodes occupied by a dielectric. (b) Artificial dielectric composed of cubic array of perfectly conducting spheres having radius R and spacing s .

Courtesy of Hermann A. Haus and James R. Melcher. Used with permission.

For spherical array of non-interacting spheres ($s \gg R$)

$$\bar{P} = 4 \pi \epsilon_0 R^3 E_0 \bar{i}_z \Rightarrow P_z = N p_z = 4 \pi \epsilon_0 R^3 E_0 N$$

$$N = \frac{1}{s^3}$$

$$\bar{P} = \epsilon_0 \left[4 \pi \left(\frac{R}{s} \right)^3 \right] \bar{E} = \psi_e \epsilon_0 \bar{E} \quad \left(\psi_e = 4 \pi \left(\frac{R}{s} \right)^3 \right)$$

ψ_e (electric susceptibility)

$$\bar{D} = \epsilon_0 \bar{E} + \bar{P} = \epsilon_0 \left[1 + \psi_e \right] \bar{E} = \epsilon \bar{E}$$

ϵ_r (relative dielectric constant)

$$\epsilon = \epsilon_r \epsilon_0 = \epsilon_0 \left[1 + \psi_e \right] = \epsilon_0 \left(1 + 4 \pi \left(\frac{R}{s} \right)^3 \right)$$

V. Demonstration: Artificial Dielectric

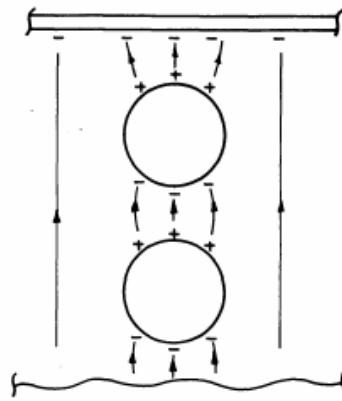

Figure 6.6.2 From the microscopic point of view, the increase in capacitance results because the dipoles adjacent to the electrode induce image charges on the electrode in addition to those from the unpaired charges on the opposite electrode.

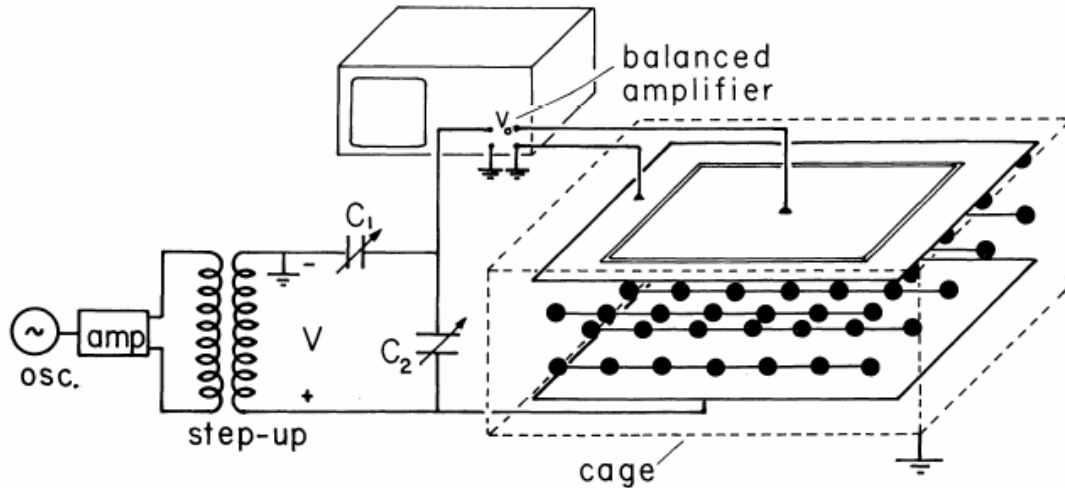

Figure 6.6.3 Demonstration in which change in capacitance is used to measure the equivalent dielectric constant of an artificial dielectric.

Courtesy of Hermann A. Haus and James R. Melcher. Used with permission.

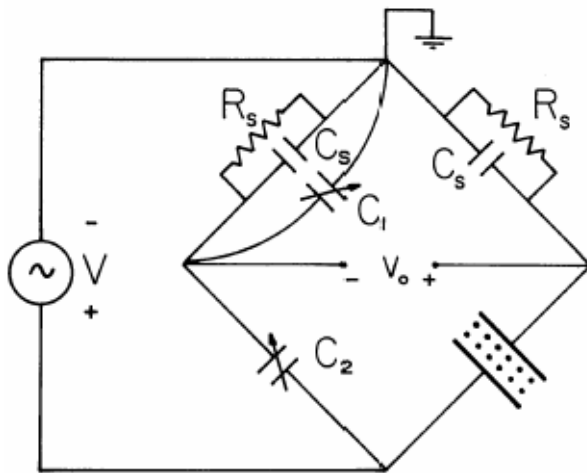

Figure 6.6.4 Balanced amplifiers of oscilloscope, balancing capacitors, and demonstration capacitor shown in Figure 6.6.4 comprise the elements in the bridge circuit. The driving voltage comes from the transformer, while v_o is the oscilloscope voltage.

Courtesy of Hermann A. Haus and James R. Melcher. Used with permission.

$$E = \frac{V}{d} \Rightarrow \sigma_s = \epsilon E = \frac{\epsilon V}{d}$$

$$q = \sigma_s A = \frac{\epsilon A}{d} V \Rightarrow C = \frac{q}{V} = \frac{\epsilon A}{d}$$

$$|\Delta i| = \omega \Delta C \quad |V| = \frac{V_o}{R_s}$$

$$\Delta C = \frac{(\epsilon - \epsilon_o) A}{d} = 4 \pi \epsilon_o \left(\frac{R}{s} \right)^3 \frac{A}{d}$$

$$R=1.87 \text{ cm}, s=8 \text{ cm}, A= (0.4)^2 \text{ m}^2, d=0.15\text{m}$$

$$\omega = 2\pi(250 \text{ Hz}), R_s=100 \text{ k}\Omega, V=566 \text{ volts peak}$$

$$\Delta C=1.5 \text{ pf}$$

$$v_o = \omega \Delta C R_s |V|$$

$$=(2\pi) (250) (1.5 \times 10^{-12}) (10^5) 566 = 0.135 \text{ volts peak}$$

VI. Plasma Conduction Model (Classical)

$$m_+ \frac{d\bar{v}_+}{dt} = q_+ \bar{E} - m_+ v_+ \bar{v}_+ - \frac{\nabla p_+}{n_+}$$

$$m_- \frac{d\bar{v}_-}{dt} = -q_- \bar{E} - m_- v_- \bar{v}_- - \frac{\nabla p_-}{n_-}$$

$$p_+ = n_+ kT, \quad p_- = n_- kT$$

$$k = 1.38 \times 10^{-23} \text{ joules/}^\circ\text{K Boltzmann Constant}$$

A. London Model of Superconductivity [$T \rightarrow 0, v_{\pm} \rightarrow 0$]

$$m_+ \frac{d\bar{v}_+}{dt} = q_+ \bar{E}, \quad m_- \frac{d\bar{v}_-}{dt} = -q_- \bar{E}$$

$$\bar{j}_+ = q_+ n_+ \bar{v}_+, \quad \bar{j}_- = -q_- n_- \bar{v}_-$$

$$\frac{d\bar{j}_+}{dt} = \frac{d}{dt} (q_+ n_+ \bar{v}_+) = q_+ n_+ \frac{d\bar{v}_+}{dt} = q_+ n_+ \frac{(q_+ \bar{E})}{m_+} = \underbrace{q_+^2 n_+}_{\omega_{p+}^2 \epsilon} \bar{E}$$

$$\frac{d\bar{j}_-}{dt} = -\frac{d}{dt} (q_- n_- \bar{v}_-) = -q_- n_- \frac{d\bar{v}_-}{dt} = -q_- n_- \frac{(-q_- \bar{E})}{m_-} = \underbrace{q_-^2 n_-}_{\omega_{p-}^2 \epsilon} \bar{E}$$

$$\omega_{p+}^2 = \frac{q_+^2 n_+}{m_+ \epsilon}, \quad \omega_{p-}^2 = \frac{q_-^2 n_-}{m_- \epsilon} \quad (\omega_p = \text{plasma frequency})$$

For electrons: $q_- = 1.6 \times 10^{-19}$ Coulombs, $m_- = 9.1 \times 10^{-31}$ kg

$$n_- = 10^{20}/\text{m}^3, \quad \epsilon = \epsilon_0 \approx 8.854 \times 10^{-12} \text{ farads/m}$$

$$\omega_{p-} = \sqrt{\frac{q_-^2 n_-}{m_- \epsilon}} \approx 5.6 \times 10^{11} \text{ rad/s}$$

$$f_{p-} = \frac{\omega_{p-}}{2\pi} \approx 9 \times 10^{10} \text{ Hz}$$

B. Drift-Diffusion Conduction [Neglect inertia]

$$m_+ \frac{d\bar{v}_+}{dt} = q_+ \bar{E} - m_+ v_+ \bar{v}_+ - \frac{\nabla(n_+ k T)}{n_+} \Rightarrow \bar{v}_+ = \frac{q_+}{m_+ v_+} \bar{E} - \frac{k T}{m_+ v_+ n_+} \nabla n_+$$

$$m_- \frac{d\bar{v}_-}{dt} = -q_- \bar{E} - m_- v_- \bar{v}_- - \frac{\nabla(n_- k T)}{n_-} \Rightarrow \bar{v}_- = \frac{-q_-}{m_- v_-} \bar{E} - \frac{k T}{m_- v_- n_-} \nabla n_-$$

$$\bar{J}_+ = q_+ n_+ \bar{v}_+ = \frac{q_+^2 n_+}{m_+ v_+} \bar{E} - \frac{q_+ k T}{m_+ v_+} \nabla n_+$$

$$\bar{J}_- = -q_- n_- \bar{v}_- = \frac{q_-^2 n_-}{m_- v_-} \bar{E} + \frac{q_- k T}{m_- v_-} \nabla n_-$$

$$\rho_+ = q_+ n_+ , \quad \rho_- = -q_- n_-$$

$$\bar{J}_+ = \rho_+ \mu_+ \bar{E} - D_+ \nabla \rho_+$$

$$\bar{J}_- = -\rho_- \mu_- \bar{E} - D_- \nabla \rho_-$$

$$\mu_+ = \frac{q_+}{m_+ v_+} , \quad D_+ = \frac{k T}{m_+ v_+}$$

$$\underbrace{\mu_- = \frac{q_-}{m_- v_-}}_{\text{charge mobilities}} , \quad \underbrace{D_- = \frac{k T}{m_- v_-}}_{\substack{\text{Molecular} \\ \text{Diffusion} \\ \text{Coefficients}}}$$

$$\underbrace{\frac{D_+}{\mu_+} = \frac{D_-}{\mu_-} = \frac{k T}{q}}_{\text{Einstein's Relation}} = \text{thermal voltage (25 mV @ } T \approx 300^\circ \text{ K)}$$

Einstein's Relation

C. Drift-Diffusion Conduction Equilibrium ($\bar{J}_+ = \bar{J}_- = 0$)

$$\bar{J}_+ = 0 = \rho_+ \mu_+ \bar{E} - D_+ \nabla \rho_+ = -\rho_+ \mu_+ \nabla \Phi - D_+ \nabla \rho_+$$

$$\bar{J}_- = 0 = -\rho_- \mu_- \bar{E} - D_- \nabla \rho_- = \rho_- \mu_- \nabla \Phi - D_- \nabla \rho_-$$

$$\nabla \Phi = -\frac{D_+}{\rho_+ \mu_+} \nabla \rho_+ = \frac{-kT}{q} \nabla (\ln \rho_+)$$

$$\nabla \Phi = \frac{D_-}{\rho_- \mu_-} \nabla \rho_- = \frac{kT}{q} \nabla (\ln \rho_-)$$

$$\left. \begin{aligned} \rho_+ &= \rho_0 e^{-q\Phi/kT} \\ \rho_- &= -\rho_0 e^{+q\Phi/kT} \end{aligned} \right\} \text{ Boltzmann Distributions}$$

$$\rho_+(\Phi = 0) = -\rho_-(\Phi = 0) = \rho_0 \quad [\text{Potential is zero when system is charge neutral}]$$

$$\nabla^2 \Phi = \frac{-\rho}{\epsilon} = -\frac{(\rho_+ + \rho_-)}{\epsilon} = \frac{-\rho_0}{\epsilon} [e^{-q\Phi/kT} - e^{+q\Phi/kT}] = \frac{2\rho_0}{\epsilon} \sinh \frac{q\Phi}{kT}$$

(Poisson-Boltzmann Equation)

$$\text{Small Potential Approximation: } \frac{q\Phi}{kT} \ll 1$$

$$\sinh \frac{q\Phi}{kT} \approx \frac{q\Phi}{kT}$$

$$\nabla^2 \Phi - \frac{2\rho_0 q}{\epsilon k T} \Phi = 0$$

$$\nabla^2 \Phi - \frac{\Phi}{L_d^2} = 0 ; \quad L_d = \sqrt{\frac{\epsilon k T}{2 \rho_0 q}} \quad \text{Debye Length}$$

D. Case Studies

1. Planar Sheet

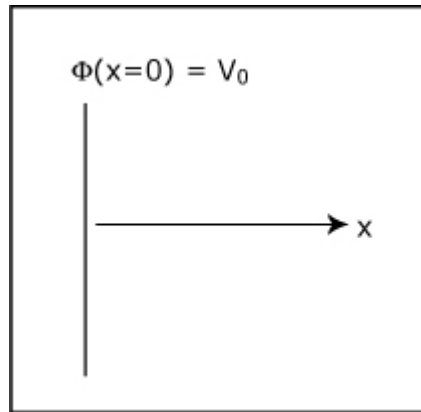

$$\frac{d^2\Phi}{dx^2} - \frac{\Phi}{L_d^2} = 0 \Rightarrow \Phi = A_1 e^{x/L_d} + A_2 e^{-x/L_d}$$

$$\text{B.C. } \Phi(x \rightarrow \pm\infty) = 0 \Rightarrow \Phi(x) = \begin{cases} V_0 e^{-x/L_d} & x > 0 \\ V_0 e^{+x/L_d} & x < 0 \end{cases}$$
$$\Phi(x=0) = V_0$$

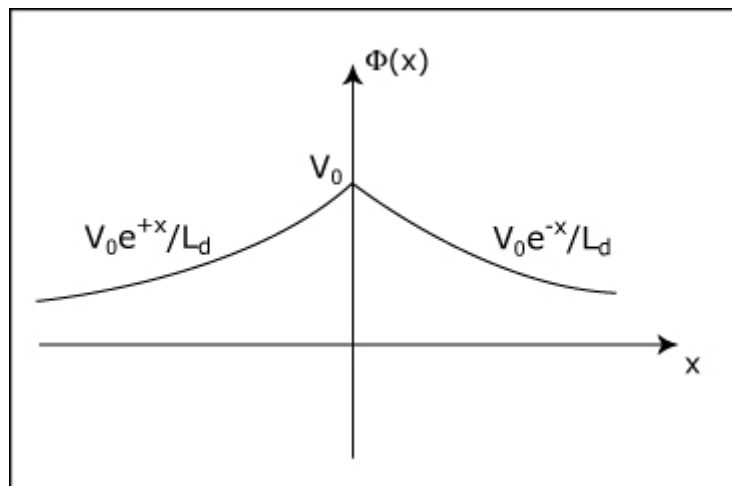

$$E_x = -\frac{d\Phi}{dx} = \begin{cases} \frac{V_0}{L_d} e^{-x/L_d} & x > 0 \\ -\frac{V_0}{L_d} e^{x/L_d} & x < 0 \end{cases}$$

$$\rho = \epsilon \frac{dE_x}{dx} = \begin{cases} -\frac{\epsilon V_0}{L_d^2} e^{-x/L_d} & x > 0 \\ -\frac{\epsilon V_0}{L_d^2} e^{+x/L_d} & x < 0 \end{cases}$$

$$\sigma_s(x=0) = \epsilon [E_x(x=0_+) - E_x(x=0_-)] = \frac{2\epsilon V_0}{L_d}$$

2. Point Charge (Debye Shielding)

$$\underbrace{\nabla^2 \Phi - \frac{\Phi}{L_d^2}} = 0 \quad \Rightarrow \quad \frac{d^2}{dr^2}(r\Phi) - \frac{r\Phi}{L_d^2} = 0$$

$$\frac{1}{r^2} \frac{\partial}{\partial r} \left(r^2 \frac{\partial \Phi}{\partial r} \right) \quad r\Phi = A_1 e^{-r/L_d} + A_2 e^{+r/L_d}$$

$$= \frac{1}{r} \frac{\partial^2}{\partial r^2} (r\Phi) \quad \Phi(r) = \frac{Q}{4\pi\epsilon r} e^{-r/L_d}$$

E. Ohmic Conduction

$$\vec{J}_+ = \rho_+ \mu_+ \vec{E} - D_+ \nabla \rho_+$$

$$\vec{J}_- = -\rho_- \mu_- \vec{E} - D_- \nabla \rho_-$$

If charge density gradients small, then $\nabla \rho_{\pm}$ negligible $\Rightarrow \rho_+ = -\rho_- = \rho_0$

$$\vec{J} = \vec{J}_+ + \vec{J}_- = (\rho_+ \mu_+ - \rho_- \mu_-) \vec{E} = \underbrace{\rho_0 (\mu_+ + \mu_-)} \vec{E} = \sigma \vec{E}$$

$\sigma =$ ohmic conductivity

$$\vec{J} = \sigma \vec{E} \text{ (Ohm's Law)}$$

$P = N_A$	-	+	$n = N_D$
$n = \frac{n_i^2}{N_A}$	-	+	$p = \frac{n_i^2}{N_D}$

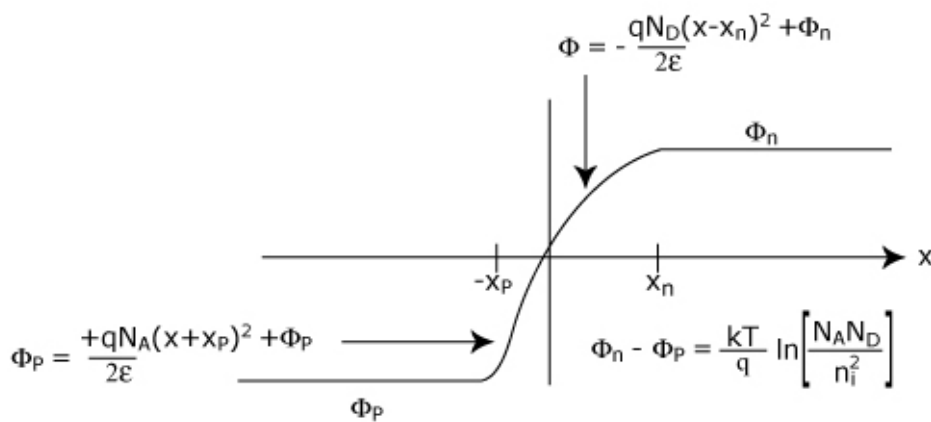
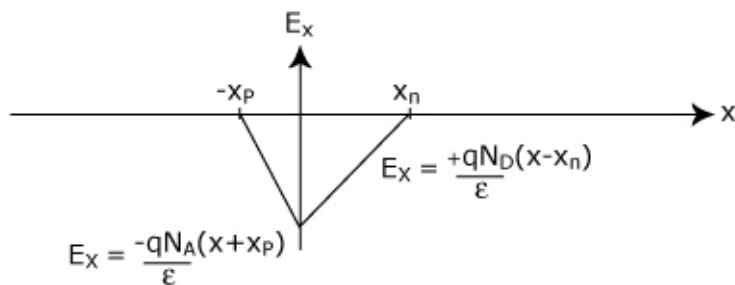
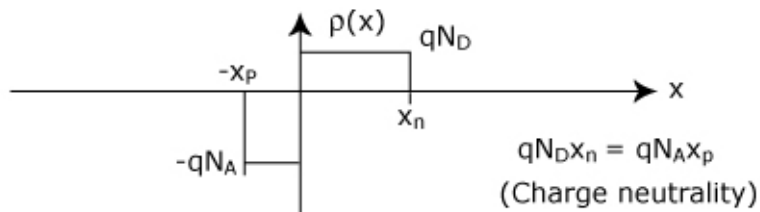

$$p = N_A = n_i e^{-q\Phi_p/kT}$$

$$\Phi_p = \frac{-kT}{q} \ln \frac{N_A}{n_i}$$

$$n = N_D = n_i e^{q\Phi_n/kT}$$

$$\Phi_n = \frac{kT}{q} \ln \frac{N_D}{n_i}$$

$$x_p = \left[\frac{\left(\frac{2\epsilon}{q} \right) \frac{N_D}{N_A} (\Phi_n - \Phi_p)}{(N_A + N_D)} \right]^{1/2}$$

$$x_n = \left[\frac{\left(\frac{2\epsilon}{q} \right) \left(\frac{N_A}{N_D} \right) (\Phi_n - \Phi_p)}{(N_A + N_D)} \right]^{1/2}$$

$$\Delta\Phi = \Phi_n - \Phi_p = \frac{kT}{q} \ln \frac{N_A N_D}{n_i^2}$$

$$\Phi(x=0) = \Phi_p + \frac{qN_A x_p^2}{2\varepsilon} = \Phi_n - \frac{qN_D x_n^2}{2\varepsilon}$$

$$\begin{aligned} \Delta\Phi = \Phi_n - \Phi_p &= \frac{qN_D x_n^2}{2\varepsilon} + \frac{qN_A x_p^2}{2\varepsilon} \\ &= \frac{qN_D x_n}{2\varepsilon} (x_n + x_p) = \frac{qN_D x_n^2}{2\varepsilon} \left(1 + \frac{N_D}{N_A}\right) \end{aligned}$$

VII. Relationship Between Resistance and Capacitance In Uniform Media Described by ϵ and σ .

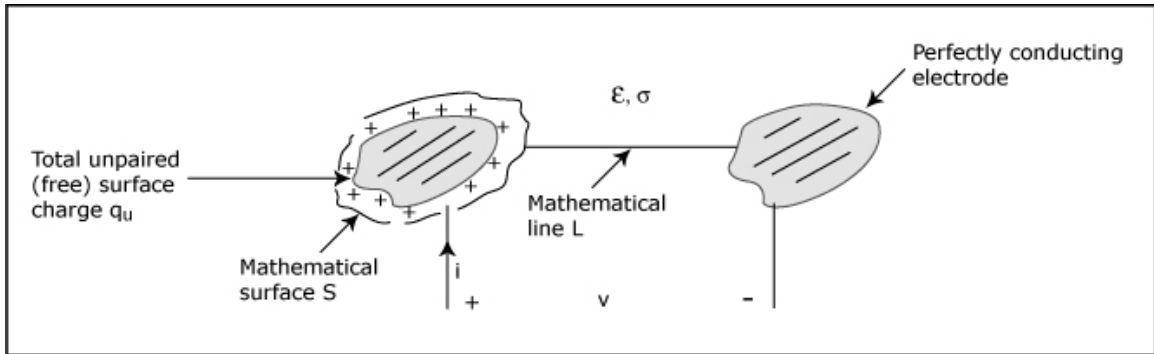

$$C = \frac{q_u}{v} = \frac{\oint_S \bar{D} \cdot d\bar{a}}{\int_L \bar{E} \cdot d\bar{s}} = \frac{\epsilon \oint_S \bar{E} \cdot d\bar{a}}{\int_L \bar{E} \cdot d\bar{s}}$$

$$R = \frac{v}{i} = \frac{\int_L \bar{E} \cdot d\bar{s}}{\oint_S \bar{J} \cdot d\bar{a}} = \frac{\int_L \bar{E} \cdot d\bar{s}}{\sigma \oint_S \bar{E} \cdot d\bar{a}}$$

$$RC = \frac{\int_L \bar{E} \cdot d\bar{s}}{\sigma \oint_S \bar{E} \cdot d\bar{a}} \cdot \frac{\epsilon \oint_S \bar{E} \cdot d\bar{a}}{\int_L \bar{E} \cdot d\bar{s}} = \frac{\epsilon}{\sigma}$$

Check:

Parallel Plate Electrodes: $R = \frac{l}{\sigma A}$, $C = \frac{\epsilon A}{l} \Rightarrow RC = \frac{\epsilon}{\sigma}$

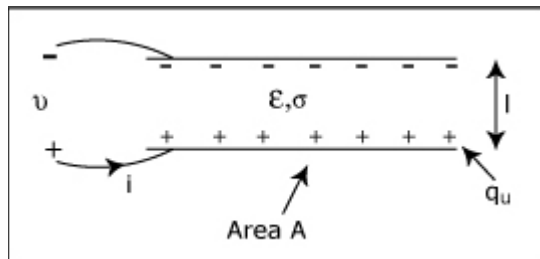

Coaxial

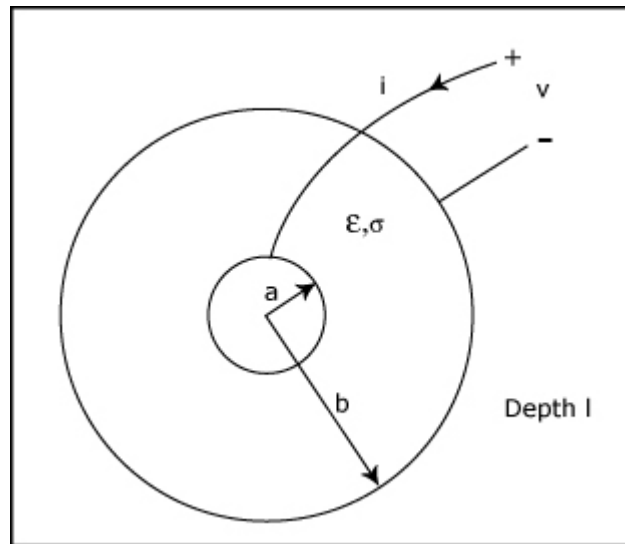

$$R = \frac{\ln b/a}{2\pi\sigma l}, \quad C = \frac{2\pi\epsilon l}{\ln b/a} \Rightarrow RC = \epsilon/\sigma$$

Concentric Spherical

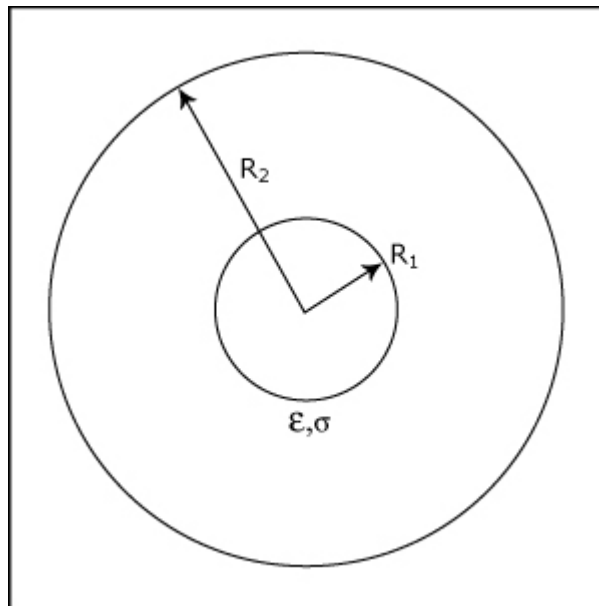

$$R = \frac{1}{4\pi\sigma} \left(\frac{1}{R_1} - \frac{1}{R_2} \right), \quad C = \frac{4\pi\epsilon}{\frac{1}{R_1} - \frac{1}{R_2}} \Rightarrow RC = \epsilon/\sigma$$

VIII. Change Relaxation in Uniform Conductors

$$\nabla \cdot \bar{J}_u + \frac{\partial \rho_u}{\partial t} = 0$$

$$\nabla \cdot \bar{E} = \rho_u / \epsilon$$

$$\bar{J}_u = \sigma \bar{E}$$

$$\sigma \underbrace{\nabla \cdot \bar{E}}_{\rho_u / \epsilon} + \frac{\partial \rho_u}{\partial t} = 0 \Rightarrow \frac{\partial \rho_u}{\partial t} + \frac{\sigma}{\epsilon} \rho_u = 0$$

$$\tau_e = \epsilon / \sigma = \text{dielectric relaxation time}$$

$$\frac{\partial \rho_u}{\partial t} + \frac{\rho_u}{\tau_e} = 0 \Rightarrow \rho_u = \rho_0(\vec{r}, t=0) e^{-t/\tau_e}$$

IX. Demonstration 7.7.1 – Relaxation of Charge on Particle in Ohmic Conductor

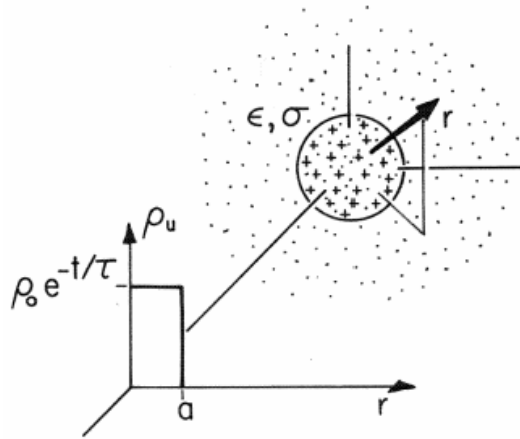

Figure 7.7.1 Within a material having uniform conductivity and permittivity, initially there is a uniform charge density ρ_u in a spherical region, having radius a . In the surrounding region the charge density is given to be initially zero and found to be always zero. Within the spherical region, the charge density is found to decay exponentially while retaining its uniform distribution.

Courtesy of Hermann A. Haus and James R. Melcher. Used with permission.

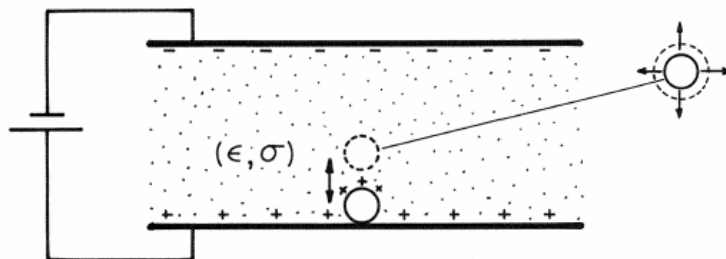
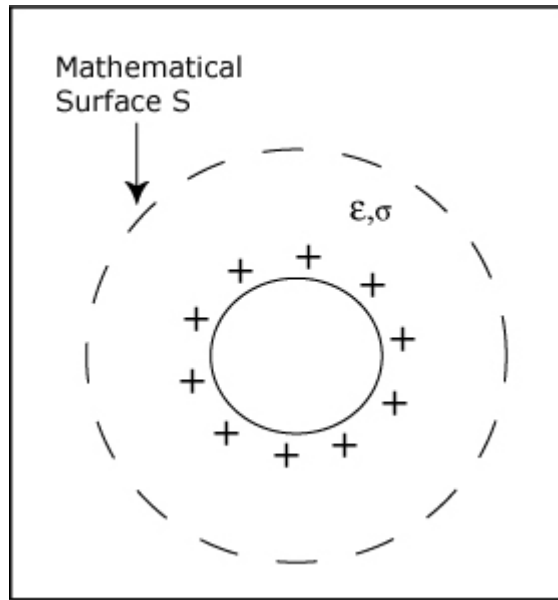

Figure 7.7.2 The region between plane parallel electrodes is filled by a semi-insulating liquid. With the application of a constant potential difference, a metal particle resting on the lower plate makes upward excursions into the fluid. [See footnote 1.]

Courtesy of Hermann A. Haus and James R. Melcher. Used with permission.



$$\oint_S \vec{J} \cdot \overline{d\vec{a}} = \sigma \oint_S \vec{E} \cdot \overline{d\vec{a}} = \frac{\sigma q_{in}}{\epsilon} = \frac{-dq}{dt}$$

$$\frac{dq}{dt} + \frac{q}{\tau_e} = 0 \Rightarrow q = q(t=0) e^{-t/\tau_e} \quad (\tau_e = \epsilon/\sigma)$$

Partially Uniformly Charged Sphere

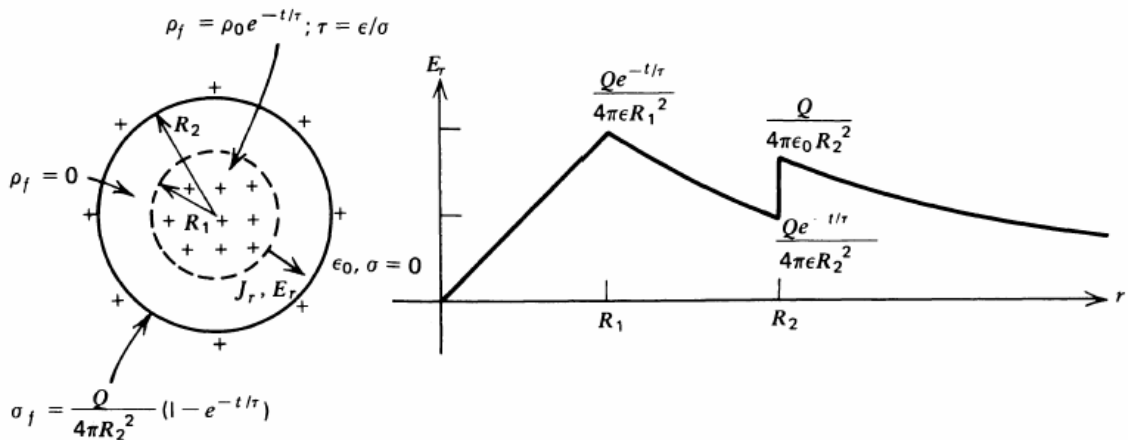

Figure 3-21 An initial volume charge distribution within an Ohmic conductor decays exponentially towards zero with relaxation time $\tau = \epsilon/\sigma$ and appears as a surface charge at an interface of discontinuity. Initially uncharged regions are always uncharged with the charge transported through by the current.

$$\rho_u(t=0) = \begin{cases} \rho_0 & r < R_1 \\ 0 & r > R_1 \end{cases} \quad Q_T = \frac{4}{3} \pi R_1^3 \rho_0$$

$$\rho_u(t) = \begin{cases} \rho_0 e^{-t/\tau_e} & r < R_1 \\ 0 & r > R_1 \end{cases} \quad (\tau_e = \epsilon/\sigma)$$

$$E_r(r,t) = \begin{cases} \frac{\rho_0 r e^{-t/\tau_e}}{3 \epsilon} = \frac{Q r e^{-t/\tau_e}}{4 \pi \epsilon R_1^3} & 0 < r < R_1 \\ \frac{Q e^{-t/\tau_e}}{4 \pi \epsilon r^2} & R_1 < r < R_2 \\ \frac{Q}{4 \pi \epsilon_0 r^2} & r > R_2 \end{cases}$$

$$\begin{aligned} \sigma_{su}(r=R_2) &= \epsilon_0 E_r(r=R_{2+}) - \epsilon E_r(r=R_{2-}) \\ &= \frac{Q}{4 \pi R_2^2} (1 - e^{-t/\tau_e}) \end{aligned}$$

X. Self-Excited Water Dynamos

A. DC High Voltage Generation (Self-Excited)

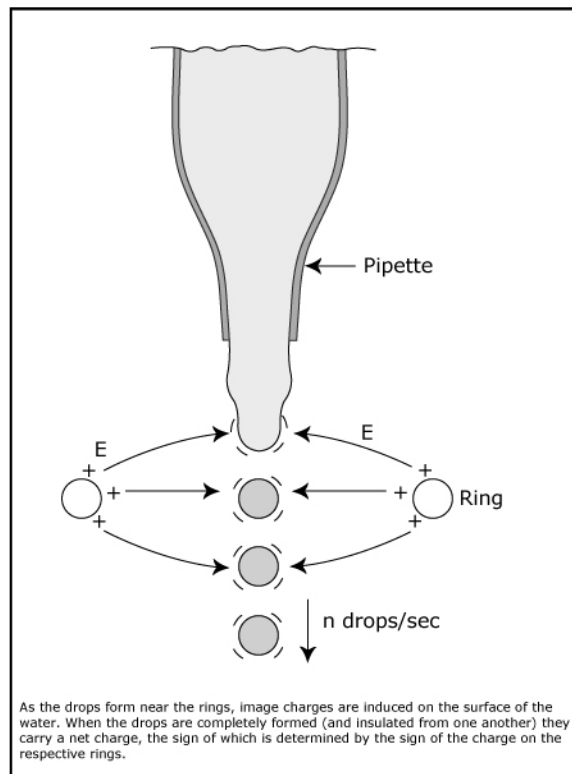

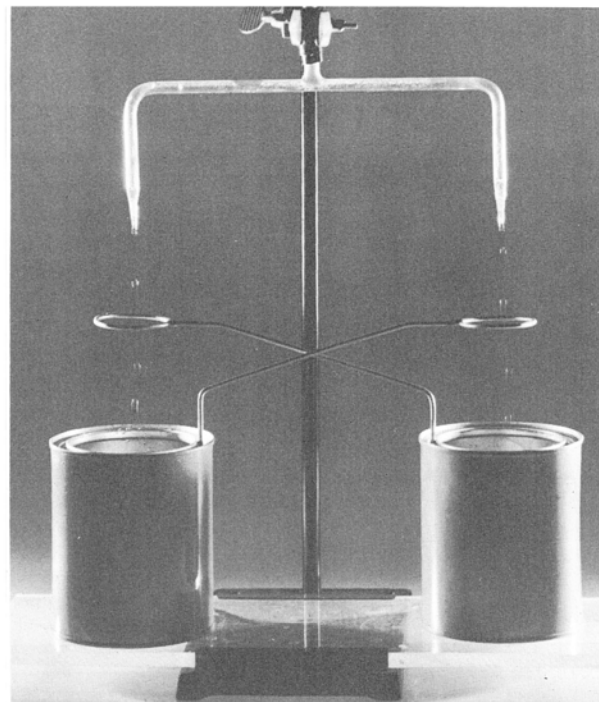
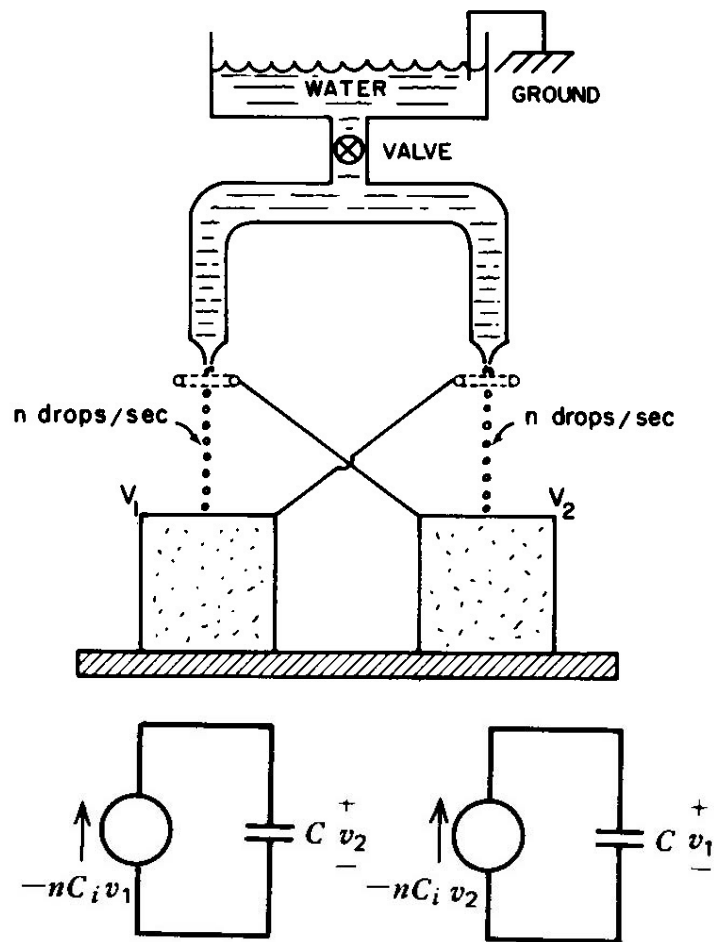

Water drops fall into the cans through cross-connected wire loops. A potential difference of more than 20 kV between cans is spontaneously generated by the motion of the drops. For optimum operation the drops should form nearer to the rings than shown. This is accomplished by increasing the flow rate.

Courtesy of Herbert Woodson and James Melcher. Used with permission. Woodson, Herbert H., and James R. Melcher. *Electromechanical Dynamics, Part 2: Fields, Forces, and Motion*. Malabar, FL: Kreiger Publishing Company, 1968. ISBN: 9780894644597.

$$\begin{aligned}
 -nC_i v_1 &= C \frac{dv_2}{dt} & v_1 &= \hat{V}_1 e^{st} & -nC_i \hat{V}_1 &= Cs \hat{V}_2 \\
 -nC_i v_2 &= C \frac{dv_1}{dt} & v_2 &= \hat{V}_2 e^{st} & -nC_i \hat{V}_2 &= Cs \hat{V}_1
 \end{aligned}$$

$$\underbrace{\begin{bmatrix} \frac{nC_i}{Cs} & 1 \\ 1 & \frac{nC_i}{Cs} \end{bmatrix}}_{\text{Det} = 0} \begin{bmatrix} \hat{V}_1 \\ \hat{V}_2 \end{bmatrix} = 0$$

$$\left(\frac{nC_i}{Cs} \right)^2 = 1 \Rightarrow s = \pm \frac{nC_i}{C}$$

⊕ root blows up

$$e^{\frac{nC_i}{C} t}$$

Any perturbation grows exponentially with time

B. AC High Voltage Self - Excited Generation

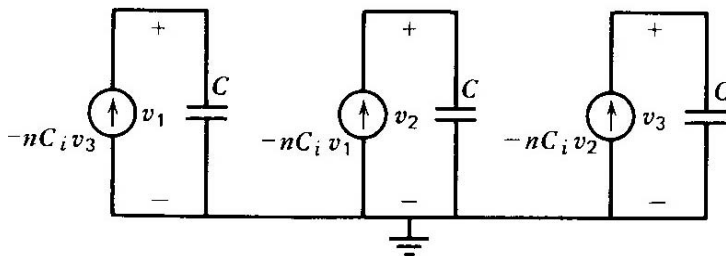

$$\begin{aligned}
 -nC_i v_1 &= C \frac{dv_2}{dt} & ; & & v_1 &= \hat{V}_1 e^{st} \\
 -nC_i v_2 &= C \frac{dv_3}{dt} & & & v_2 &= \hat{V}_2 e^{st} \\
 -nC_i v_3 &= C \frac{dv_1}{dt} & & & v_3 &= \hat{V}_3 e^{st}
 \end{aligned}$$

$$\underbrace{\begin{bmatrix} nC_i & Cs & 0 \\ 0 & nC_i & Cs \\ Cs & 0 & nC_i \end{bmatrix}}_{\text{det} = 0} \begin{bmatrix} \hat{V}_1 \\ \hat{V}_2 \\ \hat{V}_3 \end{bmatrix} = 0$$

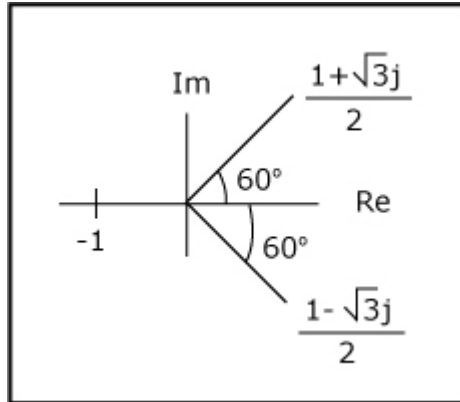

$$(nC_i)^3 + (Cs)^3 = 0 \Rightarrow s = \left(\frac{nC_i}{C}\right)(-1)^{1/3}$$

$$s_1 = -nC_i/C \text{ (exponentially decaying solution)}$$

$$(-1)^{1/3} = -1, \frac{1 \pm \sqrt{3}j}{2}$$

$$s_{2,3} = \frac{nC_i}{2C} [1 \pm \sqrt{3}j] \text{ (blows up exponentially because } s_{\text{real}} > 0 \text{ ; but also oscillates at frequency } s_{\text{imag}} \neq 0)$$

XI. Conservation of Charge Boundary Condition

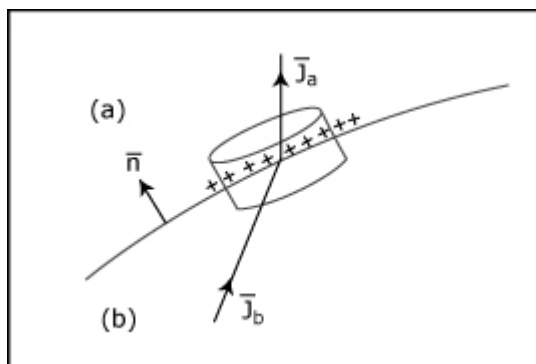

$$\nabla \cdot \bar{J}_u + \frac{\partial \rho_u}{\partial t} = 0$$

$$\oint_S \bar{J}_u \cdot d\bar{a} + \frac{d}{dt} \int_V \rho_u dV = 0$$

$$\bar{n} \cdot [\bar{J}_a - \bar{J}_b] + \frac{d}{dt} \sigma_{su} = 0$$

XII. Maxwell's Capacitor

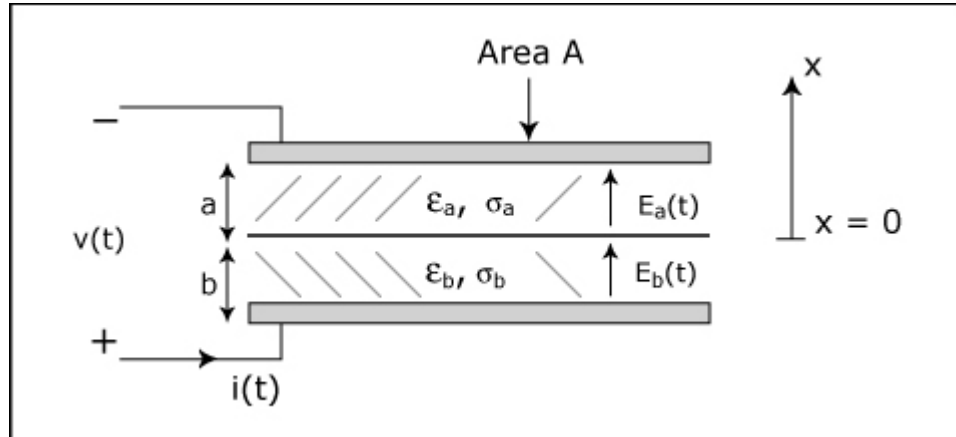

A. General Equations

$$\vec{E} = \begin{cases} E_a(t) \vec{i}_x & 0 < x < a \\ E_b(t) \vec{i}_x & -b < x < 0 \end{cases}$$

$$\int_{-b}^a E_x dx = v(t) = E_b(t)b + E_a(t)a$$

$$\vec{n} \cdot [\vec{J}_a - \vec{J}_b] + \frac{d\sigma_{su}}{dt} = 0 \Rightarrow \sigma_a E_a(t) - \sigma_b E_b(t) + \frac{d}{dt} [\epsilon_a E_a(t) - \epsilon_b E_b(t)] = 0$$

$$E_b(t) = \frac{v(t)}{b} - E_a(t) \frac{a}{b}$$

$$\sigma_a E_a(t) - \sigma_b \left[\frac{v(t)}{b} - E_a(t) \frac{a}{b} \right] + \frac{d}{dt} \left[\epsilon_a E_a(t) - \epsilon_b \left(\frac{v(t)}{b} - E_a(t) \frac{a}{b} \right) \right] = 0$$

$$\left(\epsilon_a + \frac{\epsilon_b a}{b} \right) \frac{dE_a}{dt} + \left(\sigma_a + \frac{\sigma_b a}{b} \right) E_a(t) = \frac{\sigma_b v(t)}{b} + \frac{\epsilon_b}{b} \frac{dv}{dt}$$

B. Step Voltage: $v(t) = V u(t)$

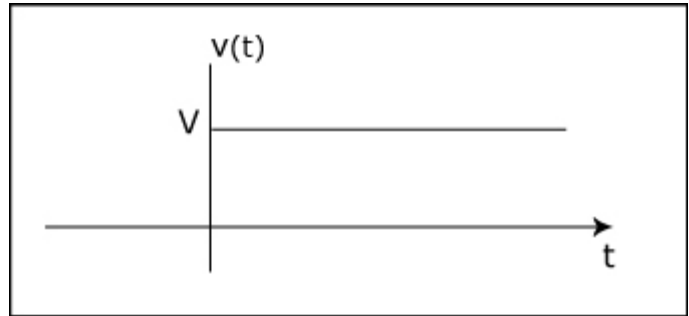

Then $\frac{dv}{dt} = V \delta(t)$ (an impulse)

At $t=0$

$$\left(\epsilon_a + \frac{\epsilon_b a}{b} \right) \frac{dE_a}{dt} = \frac{\epsilon_b}{b} \frac{dv}{dt} = \frac{\epsilon_b}{b} V \delta(t)$$

Integrate from $t=0_-$ to $t=0_+$

$$\int_{t=0_-}^{t=0_+} \left(\epsilon_a + \frac{\epsilon_b a}{b} \right) \frac{dE_a}{dt} dt = \left(\epsilon_a + \frac{\epsilon_b a}{b} \right) E_a \Big|_{t=0_-}^{t=0_+} = \int_{t=0_-}^{t=0_+} \frac{\epsilon_b}{b} V \delta(t) dt = \frac{\epsilon_b}{b} V$$

$$E_a(t = 0_-) = 0$$

$$\left(\epsilon_a + \frac{\epsilon_b a}{b} \right) E_a(t = 0_+) = \frac{\epsilon_b}{b} V \Rightarrow E_a(t = 0_+) = \frac{\epsilon_b V}{\epsilon_b b + \epsilon_b a}$$

For $t > 0$, $\frac{dv}{dt} = 0$

$$\left(\epsilon_a + \frac{\epsilon_b a}{b} \right) \frac{dE_a}{dt} + \left(\sigma_a + \frac{\sigma_b a}{b} \right) E_a(t) = \frac{\sigma_b}{b} V$$

$$E_a(t) = \frac{\sigma_b V}{\sigma_a b + \sigma_b a} + A e^{-t/\tau} ; \quad \tau = \frac{\epsilon_a b + \epsilon_b a}{\sigma_a b + \sigma_b a}$$

$$E_a(t = 0) = \frac{\sigma_b V}{\sigma_a b + \sigma_b a} + A = \frac{\epsilon_b V}{\epsilon_a b + \epsilon_b a} \Rightarrow A = V \left[\frac{\epsilon_b}{\epsilon_a b + \epsilon_b a} - \frac{\sigma_b}{\sigma_a b + \sigma_b a} \right]$$

$$E_a(t) = \frac{\sigma_b V}{\sigma_a b + \sigma_b a} (1 - e^{-t/\tau}) + \frac{\epsilon_b V}{\epsilon_a b + \epsilon_b a} e^{-t/\tau}$$

$$E_b(t) = \frac{V}{b} - E_a(t) \frac{a}{b}$$

$$\begin{aligned}
\sigma_{su}(t) &= \varepsilon_a E_a(t) - \varepsilon_b E_b(t) = \varepsilon_a E_a(t) - \varepsilon_b \left(\frac{V}{b} - \frac{a}{b} E_a(t) \right) \\
&= E_a(t) \left(\varepsilon_a + \frac{\varepsilon_b a}{b} \right) - \varepsilon_b \frac{V}{b} \\
&= \frac{V(\sigma_b \varepsilon_a - \sigma_a \varepsilon_b)}{(\sigma_a b + \sigma_b a)} (1 - e^{-t/\tau})
\end{aligned}$$

C. Sinusoidal Steady State: $v(t) = \text{Re} [\hat{V} e^{j\omega t}]$

$$E_a(t) = \text{Re} [\hat{E}_a e^{j\omega t}]$$

$$E_b(t) = \text{Re} [\hat{E}_b e^{j\omega t}]$$

Conservation of Charge Interfacial Boundary Condition

$$\sigma_a E_a(t) - \sigma_b E_b(t) + \frac{d}{dt} [\varepsilon_a E_a(t) - \varepsilon_b E_b(t)] = 0$$

$$\hat{E}_a [\sigma_a + j\omega \varepsilon_a] - \hat{E}_b [\sigma_b + j\omega \varepsilon_b] = 0$$

$$\hat{E}_b b + \hat{E}_a a = \hat{V}$$

$$\hat{E}_b = \frac{\hat{V}}{b} - \frac{\hat{E}_a a}{b}$$

$$\hat{E}_a [\sigma_a + j\omega \varepsilon_a] - \left(\frac{\hat{V}}{b} - \frac{\hat{E}_a a}{b} \right) [\sigma_b + j\omega \varepsilon_b] = 0$$

$$\hat{E}_a \left[\sigma_a + j\omega \varepsilon_a + \frac{a}{b} (\sigma_b + j\omega \varepsilon_b) \right] = \frac{\hat{V}}{b} [\sigma_b + j\omega \varepsilon_b] = 0$$

$$\frac{\hat{E}_a}{j\omega \varepsilon_b + \sigma_b} = \frac{\hat{E}_b}{j\omega \varepsilon_a + \sigma_a} = \frac{\hat{V}}{[b(\sigma_a + j\omega \varepsilon_a) + a(\sigma_b + j\omega \varepsilon_b)]}$$

$$\hat{\sigma}_{su} = \varepsilon_a \hat{E}_a - \varepsilon_b \hat{E}_b$$

$$= \frac{(\varepsilon_a \sigma_b - \varepsilon_b \sigma_a) \hat{V}}{[b(\sigma_a + j\omega \varepsilon_a) + a(\sigma_b + j\omega \varepsilon_b)]}$$

D. Equivalent Circuit (Electrode Area A)

$$\hat{I} = (\sigma_a + j\omega \varepsilon_a) \hat{E}_a A = (\sigma_b + j\omega \varepsilon_b) \hat{E}_b A$$

$$= \frac{\hat{V}}{\frac{R_a}{R_a C_a j\omega + 1} + \frac{R_b}{R_b C_b j\omega + 1}}$$

$$R_a = \frac{a}{\sigma_a A}, \quad R_b = \frac{b}{\sigma_b A}$$

$$C_a = \frac{\varepsilon_a A}{a}, \quad C_b = \frac{\varepsilon_b A}{b}$$

