

Stages of shape grammar development

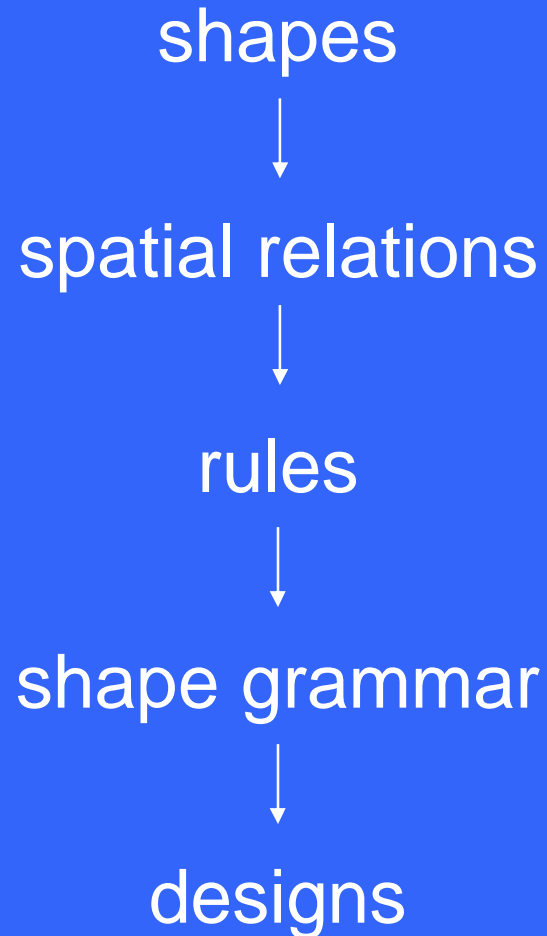

shapes

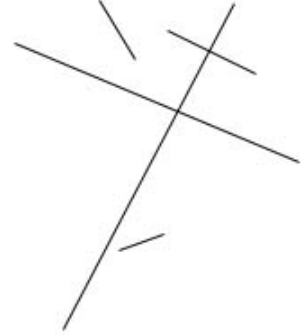
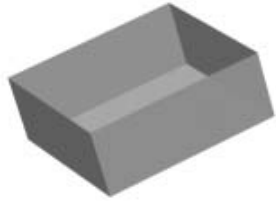

spatial relations

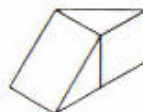
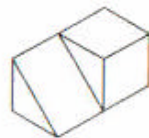
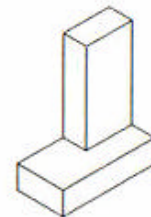
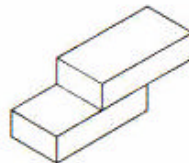
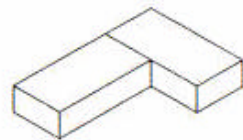
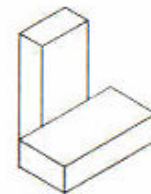
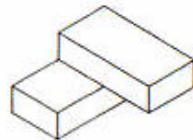
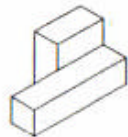

spatial relation

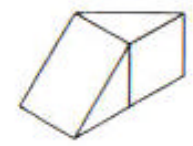
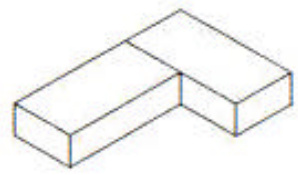

rule

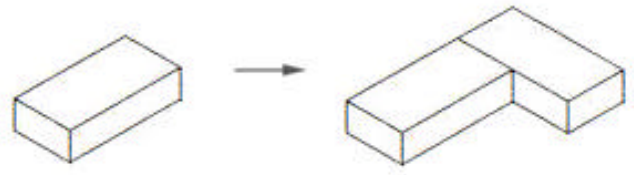

spatial relation

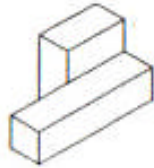

rules

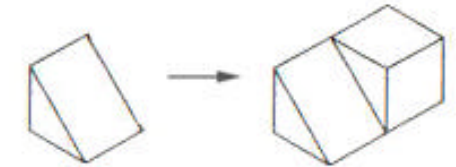
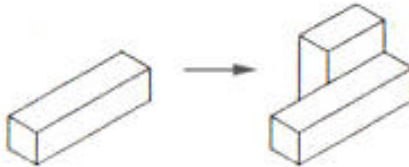
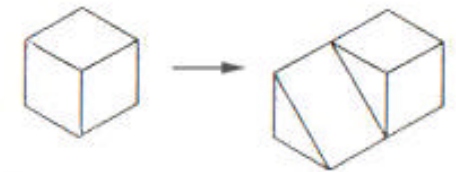
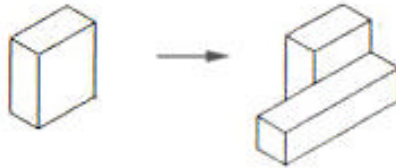

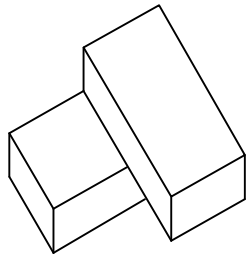

spatial relation $A + B$ between two oblongs

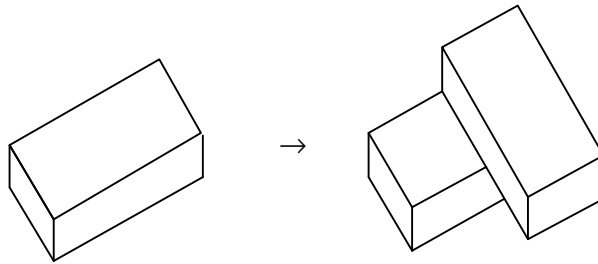

addition rule $A \rightarrow A + B$ based on the spatial relation

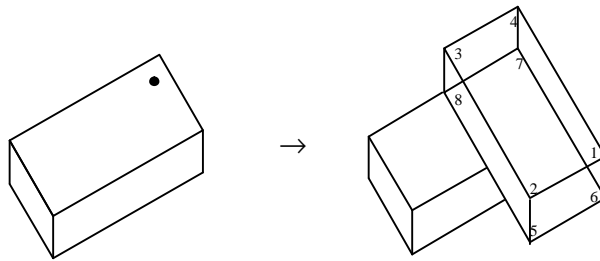

different labelings of the rule $A \rightarrow A + B$

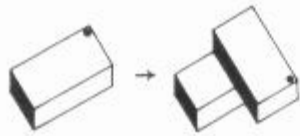

rule



design

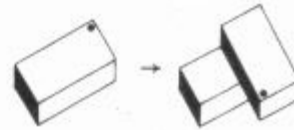

rule

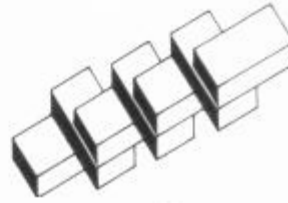

design

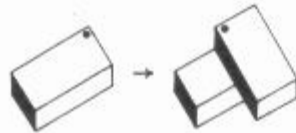

rule



design

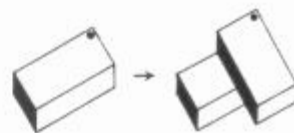

rule



design

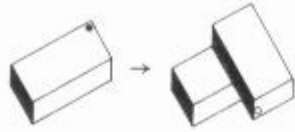

rule

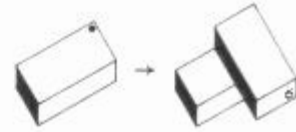

rule

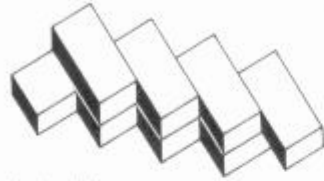

design



design

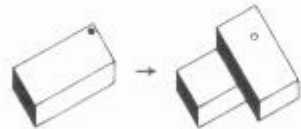

rule

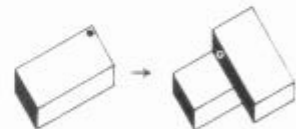

rule



design



design

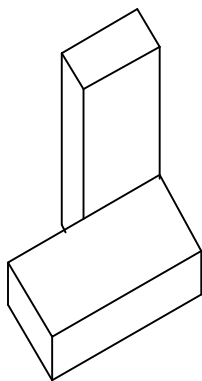

spatial relation $A + B$ between two oblongs

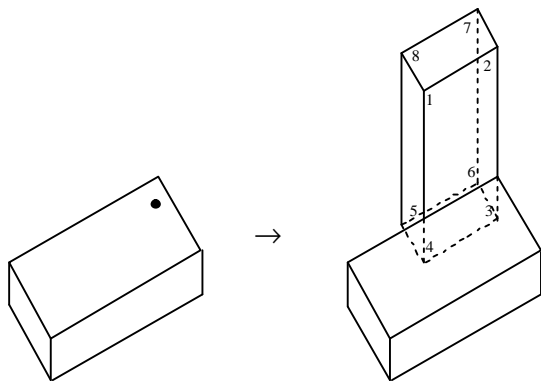

different labelings of a rule $A \rightarrow A + B$

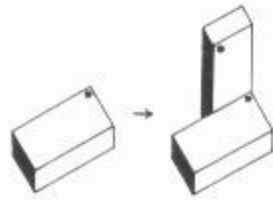

rule



design

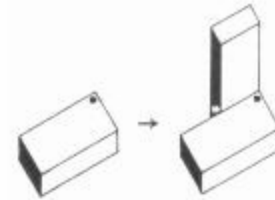

rule

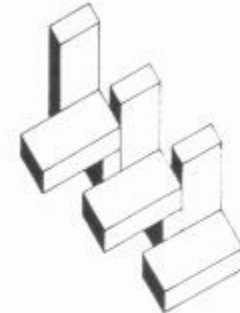

design

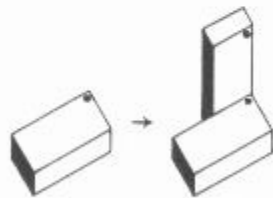

rule



design

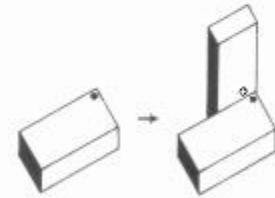

rule

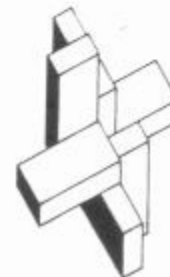

design

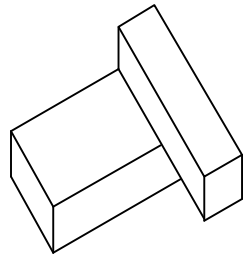

spatial relation $A + B$ between an oblong and a pillar

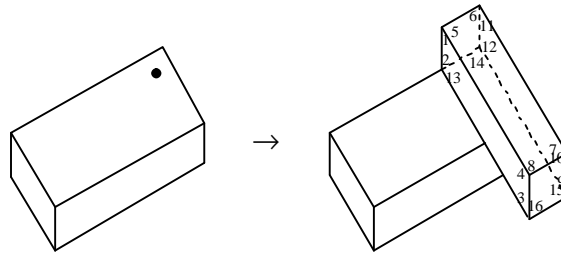

different labelings of a rule $A \rightarrow A + B$

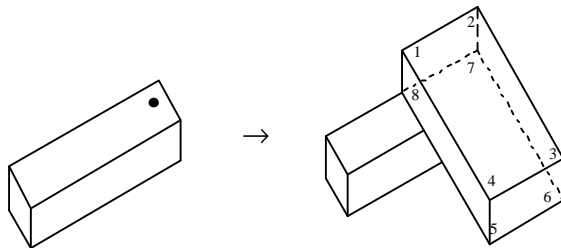

different labelings of a rule $B \rightarrow A + B$

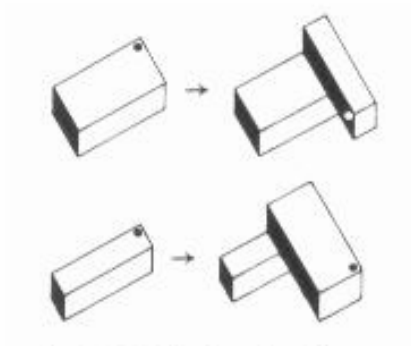

rules

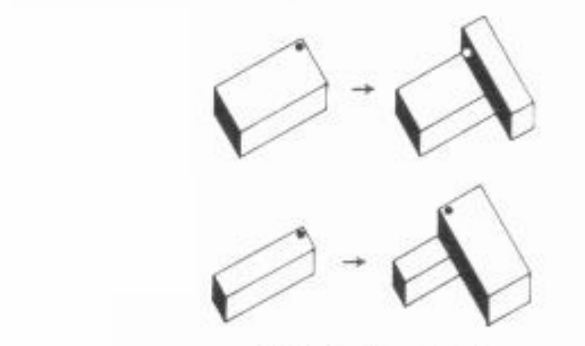

rules



design

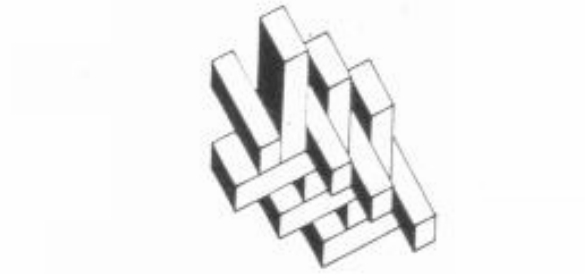

design

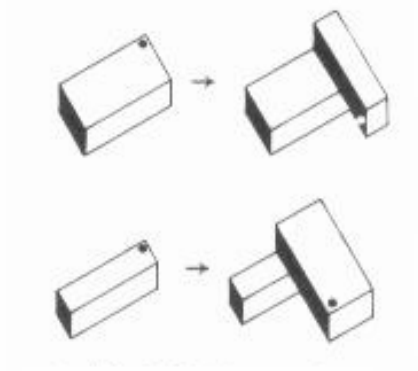

rules

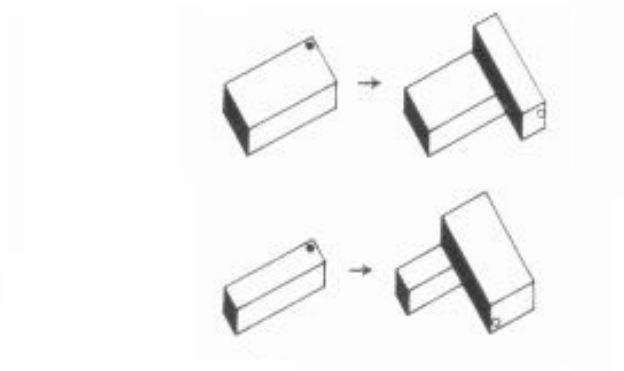

rules

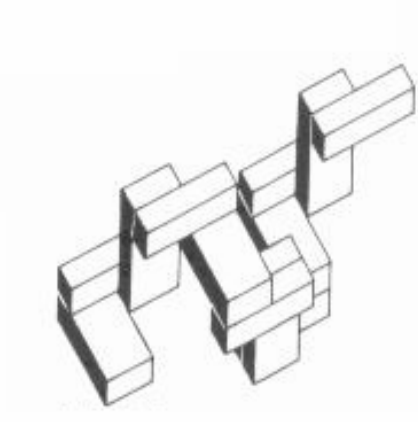

design

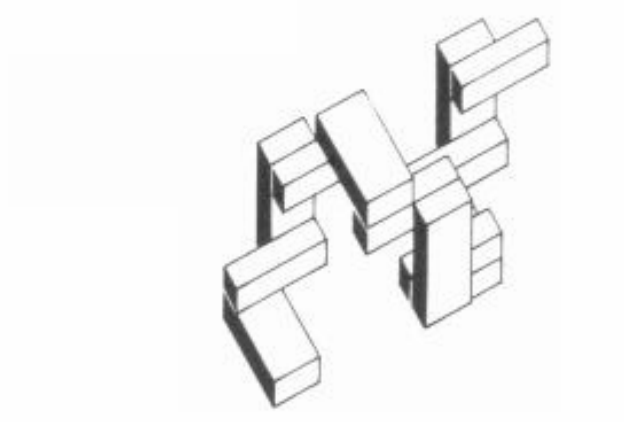

design

Assignment

Practice using 3D shape grammars.

Go back to the shape grammar examples from the lecture, and try applying labeled rules you did not do in class.